



NESS D8 CONTROL PANEL AND DIALLER



INSTALLATION & PROGRAMMING MANUAL

NESS D8 CONTROL PANEL V4 – INSTALLATION MANUAL, REVISION 1



Ness Security Products Pty Ltd



WWW.NESS.COM.AU

*“Australia’s largest
designer and
manufacturer of
high quality security
products”*

HEAD OFFICE:

Ness Security Products Pty Ltd
ACN 069 984 372
4 / 167 Prospect Hwy
Seven Hills NSW 2147 Australia
Ph +61 2 8825 9222
Fax +61 2 9674 2520
ness@ness.com.au

SYDNEY
02 8825 9222

MELBOURNE
03 9878 1022

BRISBANE
07 3343 7744

ADELAIDE (Aquavia Controls)
08 8277 7255

PERTH
08 0328 2511

NEW ZEALAND (NFS NZ)
+64 9 573 0401



NESS SECURITY PRODUCTS
Australian Communications Authority
TELECOMMUNICATIONS COMPLIANCE

D8 V4 INSTALLER MANUAL

Revision 1, November 2001

Document Part Number: 890–265

For product:

100–191 D8 LED Control Panel (V4)

100–688 D8 LCD Control Panel (V4)

© 2001 Ness Security Products Pty Ltd ACN 069 984 372
D8 V4 installer rev1 pmo221001

Specifications may change without notice.

CONTENTS

Introduction	4	Audible DTMF format	43
Features	4	Audible Pulse format	43
Specifications	4	Contact ID Reporting Codes	44
Packing list	5	Alternate Dialling	45
Installation procedures	5	Check for dial tone	45
CONNECTION DIAGRAM	6	Number of Dialling Attempts	45
Wiring examples	7	Area1 open/close reports	46
Keypad	10	Area2 open/close reports	46
OPERATION SUMMARY	11	Siren Chirp on kiss-off	46
HOW TO PROGRAM		Strobe Flash on kiss-off	46
Quick start Programming	12	Forced Opening Report	47
How to enter Program Mode	13	Delay Closing Report	47
Program mode levels	13	Manual Exclude Report	47
PROGRAMMING OPTIONS		Auto Exclude Report	47
USER CODES	14	Enable Test Calls	48
Timers	15	Mains Report Delay	48
Vibration Sensitivity	16	Listen-in to dialler	48
Zone Assignment	17–19	Swinger Shutdown	49
AREA PARTITIONING	20–21	Line Fault Monitor	49
Zone To Output Mapping	22–23	Line Fault to AUX2	49
Various Options	24–25	Remote access	50
Tamper/Keypad Panic Output Mapping	26	Direct Connect	50
System Operation Shortcuts	27	Remote access options	50–51
MONITOR MODE OUTPUT MAPPING	28	Required Rings	52
Day mode output mapping	28	FACTORY DEFAULTS	
Miscellaneous Options	29	Clear Radio Devices	53
SUPERVISED RADIO ZONES	31	Clear Memory	53
Supervision time	31	Clear Panel Options	53
Radio Supervision Alerts	32–33	Clear User Codes	53
Misc. options 1	34–35	RADIO OPTIONS	
Misc. options 2	36–37	Radio Quick Start	54
DIALLER OPTIONS		Ness Radio Interface	54
Telephone Numbers 1 & 2	38	Signal strength meter	54
Account Number 1 & 2	38	Radio Devices, Operation	55
Telephone Number 3 – Test Calls	39	Radio Supervision, Defined	55
Telephone Number 4 – Callback	39	Radio Device Programming	56
Follow me Telephone Number	39	Radio Key Programming	57
Report zone alarms	40	REMOTE OPERATION	
Report zone restorals	40	Audible Monitoring Operation	58
Report multiple zone alarms	40	Remote Operation by Telephone	59
Account No.2 zones	40	Ness Accessories	60
Report Miscellaneous alarms	41	Wireless Products	61
Report Miscellaneous Restorals	41	PROGRAMMING OPTIONS SUMMARY	62
Restoral Reporting options	41	Installation Record	63
Test Call Interval	42		
Time before Next test call	42		
Dialling Method	42		
Disable Dialler	43		
Contact ID format	43		

FEATURES

- 8 Fully programmable zones
- Any combination of hardwire or radio zones
- Full radio supervision
- Contact ID Dialler Format
- Ultra-Modern and Impact resistant Housing
- Ness Audible Dialler Format
- "Follow Me" Audible Dialler Option
- Separate 24 Hour Tamper input
- Single or Double Trigger Zones
- Remote LED or LCD Keypads (Max 3)
- Fully programmable via the system Keypad – Eliminates the need for expensive programmers or Proms.
- Inbuilt Vibration Sensor Analyser
- All programming data is permanently stored in a non-volatile EEPROM memory
- Windows based Up/Down load Software allows remote programming and event status
- True Dynamic Battery Test every time the Panel is armed / disarmed and every hour
- Area Partitionable (2 Areas). Any Zone can be programmed to any area, as well as common areas
- Comes complete with an AC plug pack and supports a 12V 7Ah battery to maintain systems security under all power supply conditions
- Monitor Mode (Home Mode)
- Outputs are separately fused with Automatic Reset Fuses
- Day Mode and Door Chime feature.
- 30 Event Memory
- Supports 8 Radio Devices (Radio PIRs, Radio Reeds etc)
- Supports 14 Radio Keys
- All inputs and outputs are heavily protected against lightning and high voltage supply transients. An earth terminal is provided for extra protection
- 15 User Codes
- 'Arm only' codes can be programmed
- Programmable Inputs to activate selectable Outputs
- Designed utilising the latest SMD Technology
- Forced Arming Feature
- Simple to Program and Use.

INTRODUCTION

The NESS D8 is a wholly Australian Designed and Manufactured product from Ness Security Products, Australia's largest manufacturer of quality electronic security products. Ness Security Products Pty Ltd is a Quality Accredited Company to ISO 9001.

This version of the D8 introduces a number of new features including Radio PIR Supervision, Ness LCD Keypad and numerous other innovations.

D8 Version 4 ENHANCEMENTS OVER Versions 3.x

RADIO

- Radio supervision. Radio supervision can be used with NESS radio detectors that transmit periodic supervision signals.
- Options added to either Toggle or Pulse Aux1 with the Radio Panic key.
- Option to have quieter siren chirps when arming/disarming with key switch or radio keys.

ARMING

- Arm only codes. Keypad codes can now be made to ARM ONLY - this does not apply to Radio key codes.
- Option for siren warning burst when arming with radio key and a zone is unsealed.
- Warning beeps timing extended by changing to Entry Delay 2 timer.
- Monitor mode outputs are now selectable for both the 2 second monitor mode and full monitor mode.
- The outputs for Area 1 and Area 2 can now be made to pulse on for 2 seconds. This makes them useful as Smoke Detector Reset outputs by adding an external relay.

DIALLER

- Aux 2 output option for telephone line fail.
- Dialler sends a CANCEL report if there has been an alarm in full monitor mode.
- Dialler Listen-In has been added via the Siren output.
- The Miscellaneous Alarm reporting options have been increased to include reports such as Mains Fail, Battery Fail, radio tamper reports and others now selectable).
- Audible Format is now more flexible in alarm reports. Mains and Battery fail reports can now be sent when using the Audible format if required.
- Closing reports can be delayed until end of exit time.
- Manual and Auto Exclude reports can be disabled.

UP/DOWNLOAD

- CallBack in Normal Mode and User Program mode is now optional to allow up/download without having a fixed callback telephone number.
- The D8 Up/Download Software is completely new and is compatible with Windows 9x. The user interface and presentation is also completely different.

HARDWARE

- An option to select 3k3 EOL resistors for Zones. Default is 2k2.
- A Tamper lead assembly has been provided to connect the internal tamper switch to the Tamp header.

MISCELLANEOUS

- Only include mains fail in alarm memory when the previous event is not mains fail.
- Fire Siren sound can be selected for 24hr zones. Handy for Smoke Detectors.
- Separate Icons added to keypad to distinguish 0 & 9 on LCD keypad.
- Day mode does not latch zone alarms. The warnings are either for 2secs or while the Day zone is unsealed.
- Zone Exclude with User Code Entry only accepts zones (1-8) that are in the AREAS that the User Code can arm.
- In User Program Mode a Siren Test can be started by entering 7777777E (8 sevens) and Dialler Test Report can be initiated by entering 66666666 (8 sixes).
- An option added which gives quiet siren chirps in Monitor mode, instead of the full volume siren sound.

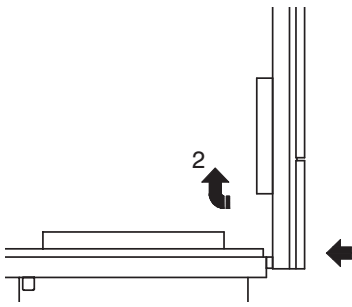

HOW TO REMOVE THE LID

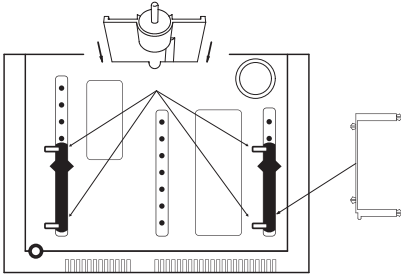

INSTALLING PCB STANDOFFS & TAMPER BRACKET

INSTALLATION PROCEDURES

The location of the main panel housing should be in an area that is within the protected area of the premises. A linen closet or cupboard are good examples as these are generally located in the centre of the Premises.

Positioning of the movement detectors should be considered as the incorrect position may cause unwanted alarms.

1. Unclip the lid by pushing in the directions of the arrows 1 and 2 as shown below.
2. Remove the Battery from the base.
3. Mount the rear panel housing to a secure location.
4. Insert the PCB stand-offs in the Panel and then plug the circuit board onto the stand-offs.
5. Wire to the circuit board terminal blocks, as per the wiring instructions shown in this installation manual.
6. Replace the Battery.
7. Insert the panel tamper bracket as shown at left.
8. Program the control panel as required

PACKING LIST

100–191 Ness D8 LED Control Panel
100–688 Ness D8 LCD Control Panel

QTY DESCRIPTION

1	D8 main board
1	D8 housing
1	Ness LED keypad (100-192) or... Ness LCD keypad (100-667)
1	17VAC plug pack
1	12V 7Ah battery (optional)
1	Dialler telephone lead
1	User manual
1	Installer manual
9	2.2K End Of Line resistors
1	Lead assembly for Battery
1	Lead assembly for Internal Tamper
1	Tamper bracket
1	Zone list label
2	Housing cover screws
2	Circuit board standoff

SPECIFICATIONS

Box construction 3mm Polycarbonate (equiv. 1.2mm mild steel)

Box Dimensions 223W x 300H x 85D mm

Plug Pack 240Vac, output 17Vac@1.4A

Power Supply 13.8Vdc @ 800mA

Quiescent Current 80mA with 1 Keypad

Operating Voltage 9.5V– 14V dc

Rechargeable Battery 12 volt 7.0 Amp/hour, lead acid

Battery Charging current 350mA maximum, current limited

Dynamic Battery Test Every Hour and on arming 10.75V with a 5 amp load

Fuses 2 Amp resettable / sirens & reset.

500mA resettable / 12 volt auxiliary outputs

200 mA resettable / strobe output

INPUTS 8 x Zone inputs

2 x 24hr Tamper inputs

End of line resistor 2200 Ohm

Remote Keypad input Proprietary

Maximum Keypads 3

J2 Header Multi-pin connector for the Ness Radio Interface (100-200)

OUTPUTS

Siren On board siren driver. Timed output.
Maximum 3 x 8 Ohm horn speakers

Strobe 12V DC latching output. Maximum 2 x 1 Watt strobe lights

Reset 12V DC timed output. Maximum 3 x 12V piezo screamers

Equipment power output 13.8V DC output for powering detectors and other equipment.
Maximum 500mA.

J3 Header Multi-pin connector provides the outputs AUX1, AUX2, ARM1,
ARM2, 12V DC.

CONNECTION DIAGRAM

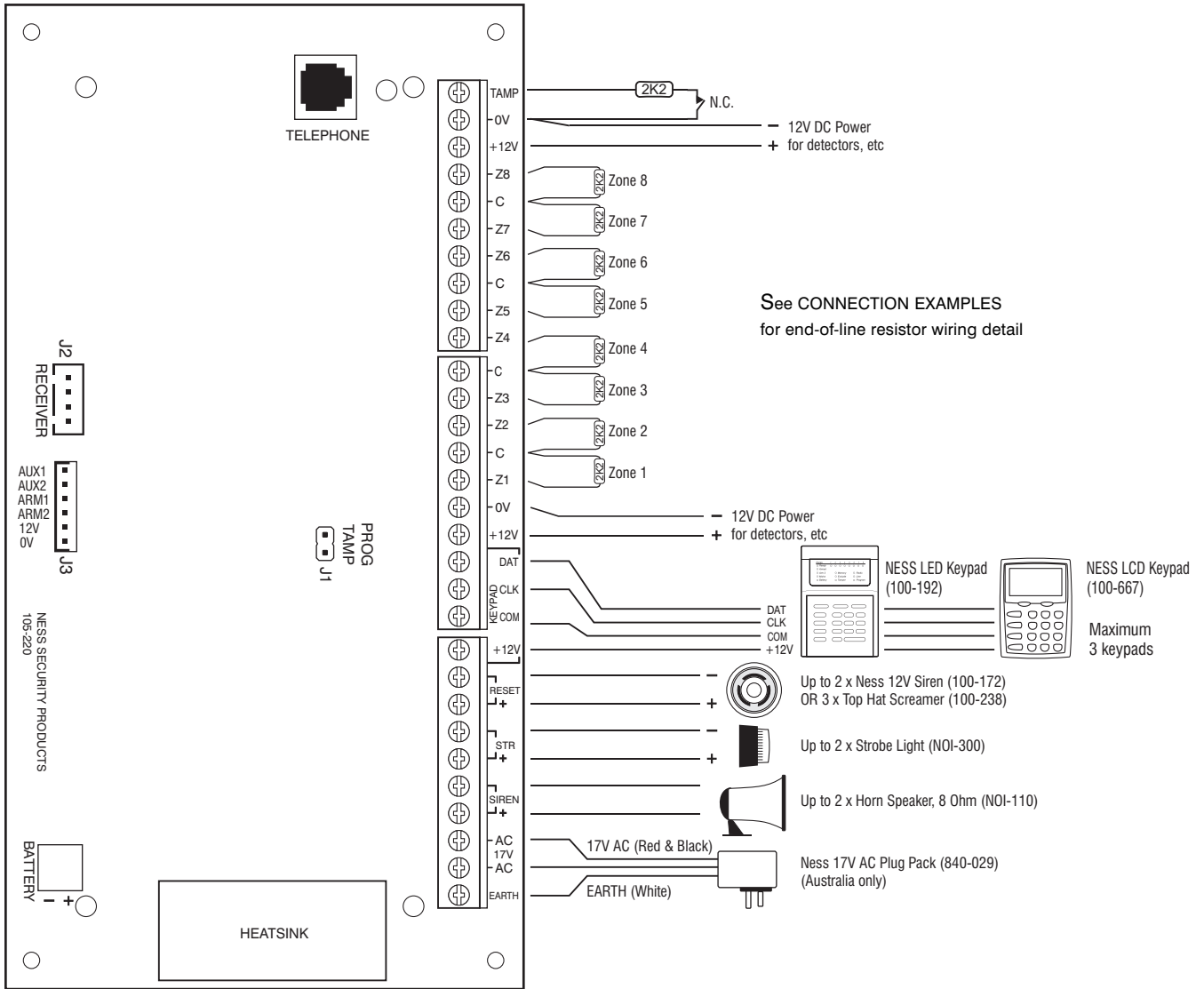

ZONE CONNECTION EXAMPLES

N.C. Normally Closed Devices

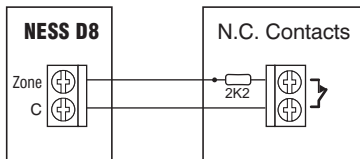

N.O. Normally Open Devices

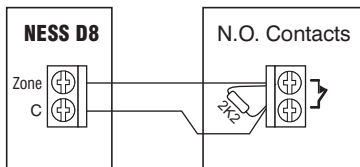

WIRING EXAMPLES

EXAMPLE 1 NESS QUANTUM DETECTORS 4 WIRE CONNECTION

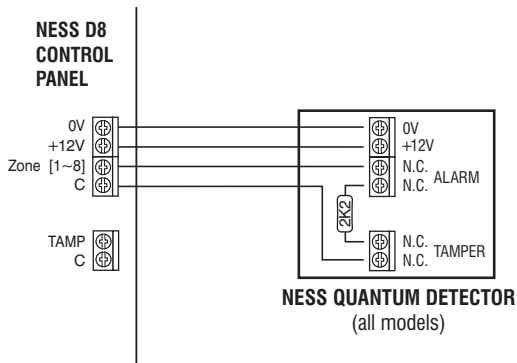

EXAMPLE 3 ANY N.C. DEVICE

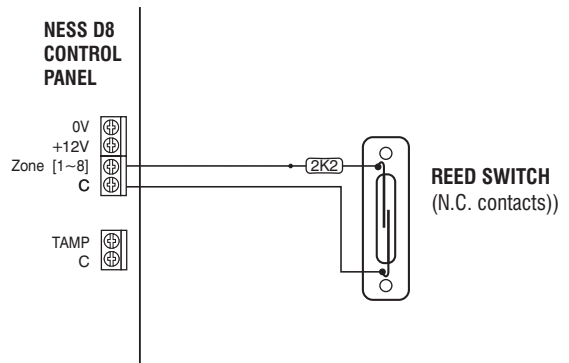

EXAMPLE 2 NESS QUANTUM DETECTORS 6 WIRE CONNECTION

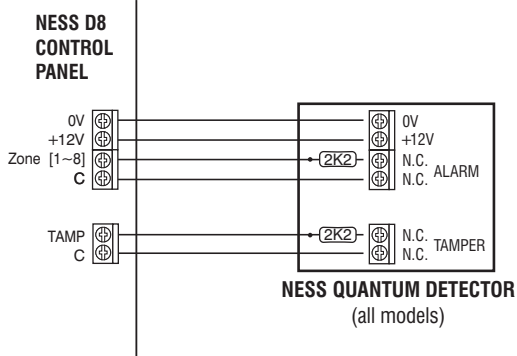

EXAMPLE 4 ANY N.O. DEVICE

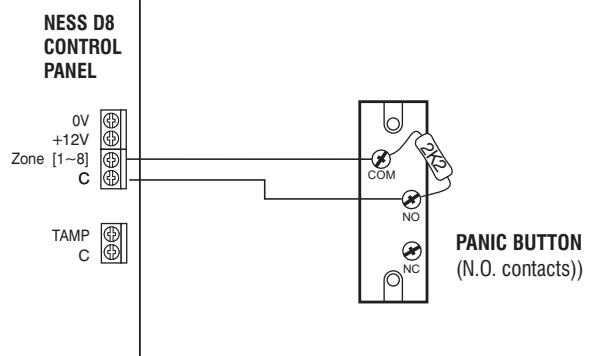

EXAMPLE 5 SIREN WIRING

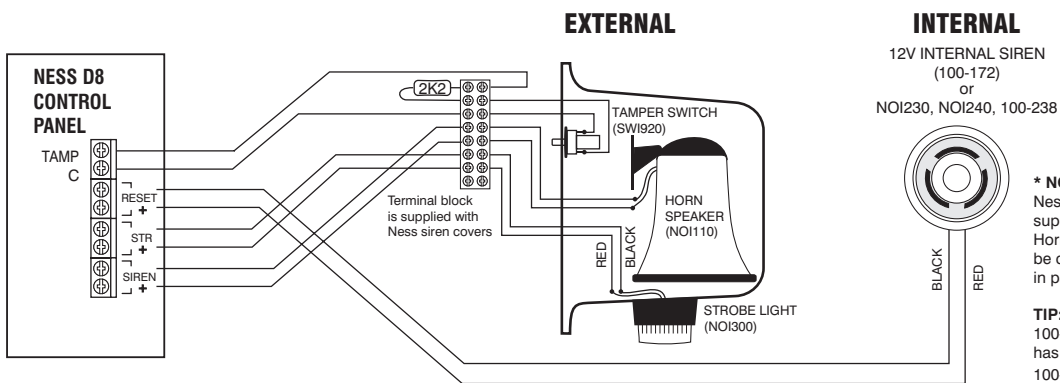

INPUTS

MONITORED ZONES

The Ness D8 has 10 separate monitored inputs.

- 8 x Fully programmable Zone inputs
- 2 x 24 hour Tamper input

ZONE INPUTS

Each zone input must be terminated with a 2K2 (2200 ohm) resistor as supplied. All inputs must be sealed with an EOL resistor even if unused.

For wiring details of Keypads, Keyswitches, Panic Buttons and Warning devices, see the wiring diagrams in the wiring section of this manual.

TAMP – Tamper Input

The TAMP input must also be sealed with a 2K2 end of line resistor. This input is always a 24hr input.

AC INPUT TERMINALS

These terminals are for the connection of the Ness plugpack. The Ness D8 requires an AC transformer rating of 1.4 Amps @ 17 V AC minimum. (Ness Part No. POW215)

BATTERY

These terminals are for the connection of a sealed lead-acid rechargeable 12Volt battery. Charge current is limited to 350mA. The charge voltage is factory preset at 13.8 V and does not need changing. Note: A 12 Volt sealed lead acid rechargeable battery must be connected for correct panel operation. Observe correct Polarity when connecting the battery.

(Ness Part Number BAT210 12V 7Ah battery)

EARTH

For maximum protection against damage caused by lightning strikes, connect a good earth to this terminal. Alternatively use the Earth lead from the plug pack.

PROG/TAMP – Program Link & Internal Tamper Input

The PROG/TAMP link appears on the two pin J1 header.

The PROG/TAMP link has two purposes:

1. **To enter Installer Program Mode on initial power up.** Power-up with the PROG link OFF. The PROG link (or Box Tamper lead) must be ON in operating mode.
2. **Box Tamper.** When used with the Internal Tamper Lead (supplied), PROG/TAMP serves as the 24hr tamper input for the panel's internal tamper switch.

Replace the PROG Link with the Box Tamper Lead. Connect the Internal Tamper Lead spade terminals directly to the terminals of the internal tamper switch (supplied). An end-of-line resistor is NOT required on this input.

When PROG/TAMP is used for Internal Tamper, powering up with the panel's cover open will enter Installer Program Mode.

OUTPUT FUSING

The 12V outputs, Siren, Reset and Strobe outputs are protected by Automatic Reset electronic fuses. These outputs will automatically reset once the overload is removed.

BACKUP BATTERY

A properly charged battery MUST be installed to ensure the Siren, Strobe and Reset outputs operate correctly.

SIREN LOAD

A maximum output of 2.0A continuous is available from the SIREN, and RESET outputs and 200mA from the STR output.

Recommended maximum power load:

- 3 x Horn speakers (SIREN output)
- 2 x Strobe lights (STR output)
- 2 x Ness Internal Sirens (100-172) (RESET output)

Note: (This assumes no more than 500mA is being drawn from the 12V device output).

J3 OPEN COLLECTOR OUTPUTS

- AUX 1
- AUX 2
- ARM 1
- ARM 2
- 12V
- 0V

OUTPUTS

12 VOLT OUTPUT:

A regulated 13.8 VDC output is available to power detectors and other equipment. This output is available from two sets of terminals marked +12V and 0V. The output is protected by an Automatic Reset fuse.

A maximum load of 500mA may be connected to these terminals.

SIREN:

The on-board siren driver will drive a maximum of 3 x 8 ohm horn speakers (Ness Part No. NOI110 or 100-171 Internal Siren). The output will reset at the end of siren time (P29E) or whenever the panel is reset, whichever comes first. The output is protected by an Automatic Reset fuse.

STR – Strobe:

A latched 12VDC output for connecting strobe lights. This output will latch on in the event of an alarm condition and stay on until the panel is reset.

A maximum of 2 x 1 Watt Strobes (Ness Part No. NOI300) can be connected to this output. The output is protected by an Automatic Reset fuse.

RESET:

A 12V DC output for connecting Ness Sirens, piezo sirens or relays, etc. This output will reset at the end of siren time (P29E) or whenever the panel is reset, whichever comes first.

A maximum of 3 x 12V piezo Sirens (Ness Part No. NOI240, NOI 230, 100-238) or 2 X Ness Piezo (Part No 100-172) can be connected to this output. The output is protected by an Automatic Reset fuse.

J3 HEADER

AUX1:

This output is an open collector (switch negative) which can supply a maximum of 100mA. Zone alarms may be selected to trigger this output by option P58E.

AUX2:

This output is an open collector (switch negative) which can supply a maximum of 100mA. Zone alarms may be selected to trigger this output by option P59E.

ARM1:

This output is an open collector (switch negative) which can supply a maximum of 100mA. This output is turned on when Area 1 is armed.

ARM2:

This output is an open collector (switch negative) which can supply a maximum of 100mA. This output is turned on when Area 2 is armed.

KEYPAD

D8 KEYPAD

The D8 control panel may be supplied with either the LED keypad (100-192) or the Ness LCD Keypad (100-667).

The keypad provides important visual and audible indications and is the main interface for operating and programming the D8 control panel.

NUMBER OF KEYPADS

Up to **3 LED and/or LCD keypads** can be connected to the D8.

CABLE LENGTH

The maximum allowable **cable length** is 100m (total cable length to all keypads).

DISPLAY TEST (LCD Keypad only)

To display all the keypad icons press and hold the (E) button for at least 2 seconds. All the icons will be on whilst the (E) button is held down.

Display Test can be activated at any time either in operating mode or any program mode.

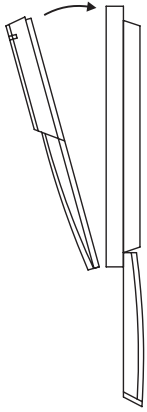

KEYPAD INSTALLATION

- Unclip the top half of the keypad housing by pushing the top clips down with a small screwdriver and pulling the housing forward.
- Screw the base of the keypad housing to the wall using the 4 mounting holes provided.
- Bring the 4 connecting wires to the terminal block on the PCB on the rear of the keypad housing.
- Connect the wires to the screw terminals as per the wiring diagram shown in this manual.
- Clip the top half onto the base by first engaging the bottom clips and swinging the top closed. Push hard to ensure the clips engage.
- Attach the Zone list label on the inside of the lid.

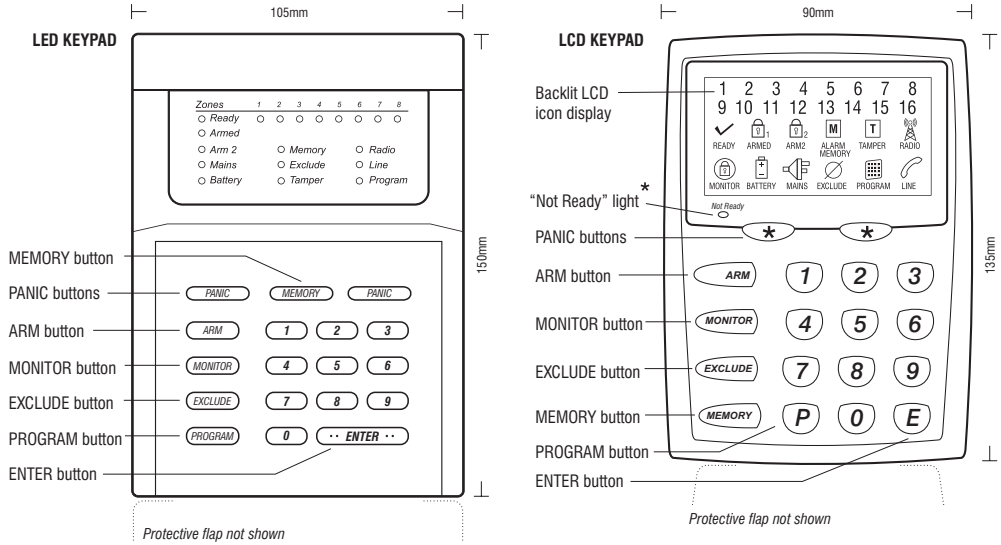





* The "Not Ready" light is on when the panel is not ready to Arm. i.e. a zone is unsealed, there may still be movement in the premises or a door or window left open

KEYPAD BEEPER SOUNDS	
Each key press	♪ 1 beep
Valid command	♪♪♪ 3 beeps
Error	♪- 1 long beep
Mains Power is off or Panel Battery is low	♪-♪-♪- 10 beeps

LED KEYPAD	LCD KEYPAD	STATUS		
		● OFF	○ ON	☀ FLASHING
ZONES 1~8		Zone is sealed	Zone is unsealed	Zone alarm
○ READY	✓ READY	Zone is unsealed, or Power fault or System is Armed, or phone line fault	Ready to Arm	
○ ARMED	🔒 ₁ ARMED	Disarmed	Armed (AREA 1)	Monitor Mode (LED Keypad only)
○ ARM2	🔒 ₂ ARM2	Disarmed	Armed (AREA 2)	
	🔒 MONITOR	Disarmed	Monitor Mode	
○ MAINS	🔊 MAINS	Normal		Mains Power is off
○ BATTERY	🔋 BATTERY	Normal		The panel's backup battery is low
○ MEMORY	📄 ALARM MEMORY	Normal	Memory Mode selected	New alarms in memory
○ EXCLUDE	🚫 EXCLUDE	Normal		Zones are excluded
○ TAMPER	🚧 TAMPER	Normal		Tamper alarm
○ RADIO	📶 RADIO	Normal	Receiving radio signal (And in Memory Mode indicates a low battery alarm from a radio device)	Indicates that a Radio Key or other radio device has a low battery
○ LINE	📞 LINE	Normal	Dialler is on line	Phone line fault or failure to communicate
○ PROGRAM	📱 PROGRAM	Normal	User Program Mode	Installer Program Mode
	ⓘ Not Ready	Ready to Arm	Not ready to Arm	

OPERATION SUMMARY

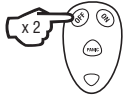
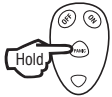
OPERATION	 LED KEYPAD	 LCD KEYPAD	 RADIO KEY
ARM	<p>ARM .. ENTER ..</p> <p>or... ARM [User Code] .. ENTER ..</p>	<p>ARM E</p> <p>or... ARM [User Code] E</p>	
DISARM	<p>[User Code] .. ENTER ..</p>	<p>[User Code] E</p>	
MONITOR MODE	<p>MONITOR .. ENTER ..</p> <p>or... MONITOR [User Code] .. ENTER ..</p>	<p>MONITOR E</p> <p>or... MONITOR [User Code] E</p>	<p>x 2</p>  <p>Press twice within 4 seconds P69E 5E must be ON</p>
PANIC	<p>PANIC PANIC Both keys together</p> <p>or... PANIC [User Code] .. ENTER ..</p> <p>Or... PANIC .. ENTER .. (Keypad Panic Shortcut must be ON, P62E 4E)</p>	<p>* * Both keys together</p> <p>or... * [User Code] E</p> <p>Or... * E (Keypad Panic Shortcut must be ON, P62E 4E)</p>	<p>Hold</p>  <p>Press and hold for 4 seconds (P68E 3E & 4E must be OFF)</p>
KEYPAD DURESS	<p>[x] [User Code] .. ENTER ..</p> <p>To Disarm and report a Duress Alarm, add any of the digits 5, 6, 8 or 9 before the User Code when Disarming</p>	<p>[x] [User Code] E</p>	
EXCLUDING ZONES	<p>EXCLUDE .. ENTER ..</p> <p>or... EXCLUDE [User Code] .. ENTER ..</p> <p>[Zone No.] .. ENTER ..] Enter the zone numbers [Zone No.] .. ENTER ..] to be Excluded</p> <p>.. ENTER .. To exit Exclude mode</p>	<p>EXCLUDE E</p> <p>or... EXCLUDE [User Code] E</p> <p>[Zone No.] E] Enter the zone numbers [Zone No.] E] to be Excluded</p> <p>E To exit Exclude mode</p>	
ALARM MEMORY	<p>MEMORY .. ENTER ..</p> <p>or... MEMORY [User Code] .. ENTER ..</p> <p>Press MEMORY repeatedly to display the last 30 events</p> <p>.. ENTER .. To exit Memory mode</p>	<p>MEMORY E</p> <p>or... MEMORY [User Code] E</p> <p>Press MEMORY repeatedly to display the last 30 events</p> <p>E To exit Memory mode</p>	

PROGRAMMING

QUICK START PROGRAMMING

Use one of these programming summaries for fast setup of your D8 as a Local, Audible Monitored or Central Station Monitored system.

The control panel will be ready for use immediately.

QUICK START 1 - step by step

QUICK START 1 LOCAL SYSTEM

Quick Start 1 shows you how to change User Code 1 (the Master Code).

By default, the dialler is disabled until programmed.

STEP	KEY STROKES	DESCRIPTION	COMMENT
1	P 1 2 3 E *	Enter User Program Mode	Program Light is ON
2	P 1 1 E	Selects the option for User Code 1	The existing code is displayed by the keypad lights, followed by 3 beeps
3	□ □ □ □ E	Enter the new User Code	Can be 3 to 6 digits long
4	□ □ □ □ E	Enter the new User Code again	The new code is displayed by the keypad lights, followed by 3 beeps
5	P E	To exit Program Mode	Program light turns OFF

QUICK START 2 - step by step

QUICK START 2 AUDIBLE MONITORING

Quick Start 2 shows you how to change User Code 1 (the Master Code), enable Audible Monitoring and program 1 telephone number. This will enable the dialler to report alarms to any telephone including mobile phones.

STEP	KEY STROKES	DESCRIPTION	COMMENT
1	P 1 2 3 E *	Enter User Program Mode	Program Light is ON
2	P 0 0 0 0 0 0 0 E *	Enter Installer Program Mode	Program Light is FLASHING
3	P 1 1 E	Selects the option for User Code 1	The existing code is displayed by the keypad lights, followed by 3 beeps
4	□ □ □ □ E	Enter the new User Code	Can be 3 to 6 digits long
5	□ □ □ □ E	Enter the new User Code again	The new code is displayed by the keypad lights, followed by 3 beeps
6	P 8 6 E 4 E	At P86E, turns ON option 4	Audible Monitoring enabled
7	P 7 0 E	Selects the option for Telephone No.1	
8	□ Up to 15 digits □ E ²	Enter the telephone number	Can be up to 15 digits long
9	P E	To exit Program Mode	Program light turns OFF

See page 58 for further information on the operation of Audible Monitoring.

QUICK START 3 - step by step

QUICK START 3 CENTRAL STATION MONITORING

Quick Start 3 shows you how to change User Code 1 (the Master Code), enable Central Station Monitoring and program one telephone number. This will enable the dialler to report alarms to a Central Station.

STEP	KEY STROKES	DESCRIPTION	COMMENT
1	P 1 2 3 E *	Enter User Program Mode	Program Light is ON
2	P 0 0 0 0 0 0 0 E *	Enter Installer Program Mode	Program Light is FLASHING
3	P 1 1 E	Selects the option for User Code 1	The existing code is displayed by the keypad lights, followed by 3 beeps
4	□ □ □ □ E	Enter the new User Code	Can be 3 to 6 digits long
5	□ □ □ □ E	Enter the new User Code again	The new code is displayed by the keypad lights, followed by 3 beeps
6	P 8 6 E 2 E ¹	At P86E, turns ON option 2	Central station Monitoring enabled
7	P 7 0 E	Selects the option for Telephone No.1	Existing Ph No (if any) displayed
8	□ Up to 15 digits □ E ²	Enter the Telephone Number	Can be up to 15 digits long
9	P 7 2 E ³	Enter the Account Number	Must be 4 digits
10	P E	To exit Program Mode	Program light turns OFF

¹ Option P86E 2E is ON by factory default. This option only needs to be turned ON if previously programmed OFF.

² The Central Station's receiver telephone number - supplied by the Central Station

³ Account Number to identify the premises - supplied by the Central Station

* Factory default Master Code is: 123

* Factory default Installer Code is: 000000

PROGRAMMING

FACTORY DEFAULT

MASTER CODE: 123
INSTALLER CODE: 000000

INSTALLER PROGRAM MODE

Installer Program Mode allows access to ALL program options.

Note: The panel will remain in Installer Program Mode indefinitely.

USER PROGRAM MODE

User Program Mode allows the owner to program:

- All User Codes
- Entry Exit Times
- Follow Me Telephone number

Note: The panel will automatically drop out of User Program Mode to Operating Mode if no keypad buttons are pressed for 4 minutes.

PROGRAM MODE LEVELS

TABLE 4. FLOW CHART

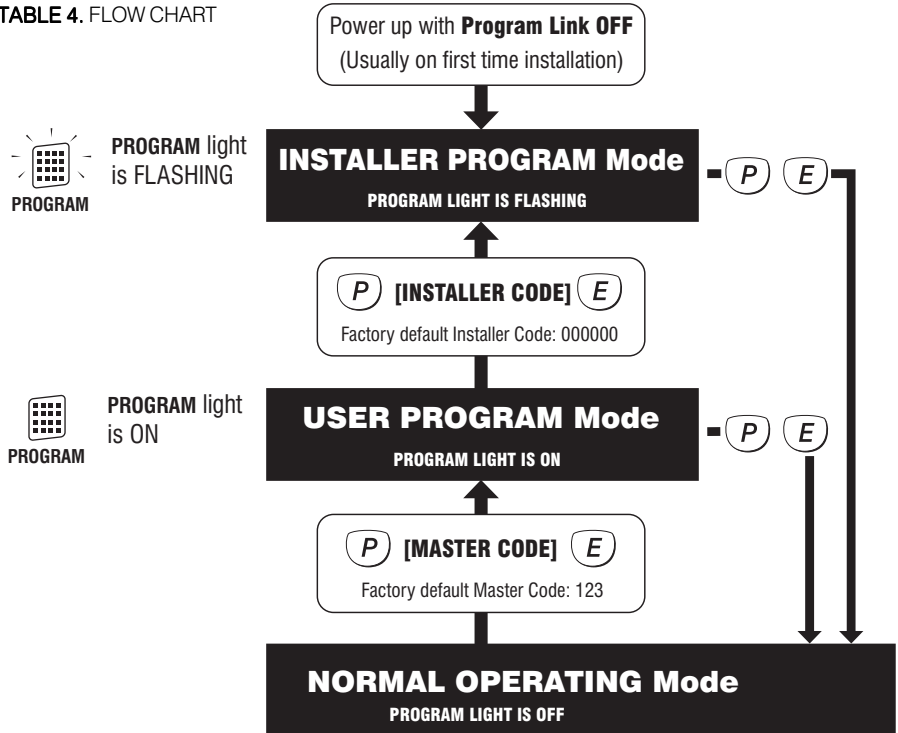

HOW TO ENTER PROGRAM MODE



A FROM POWER UP

1. Power-up with the PROG link OFF.
(The PROG link (or Box Tamper lead) must be ON in Operating Mode).

B USING KEYPAD

The panel must be Disarmed.

1. Press **P** [MASTER CODE] **E** The keypad will respond with 3 beeps This is User Program Mode (PROGRAM light is ON).
2. Press **P** [INSTALLER CODE] **E** The keypad will respond with 3 beeps This is Installer Program Mode (PROGRAM light is FLASHING).

HOW TO EXIT PROGRAM MODE

1. Press **P** then **E**
This is Operating Mode (PROGRAM light is OFF).

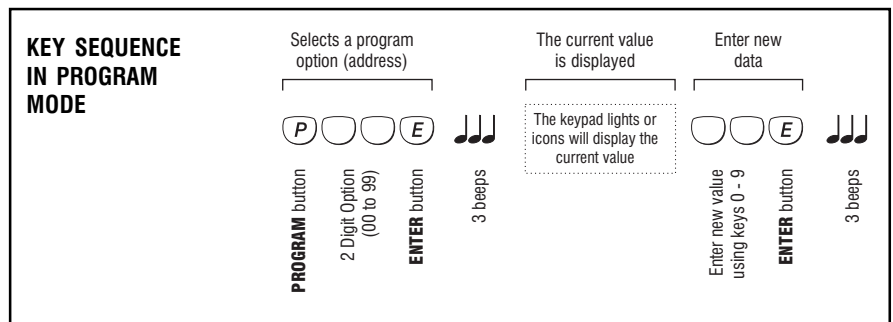

PROGRAMMING

P01E – P10E

P11E – P25E

PROGRAM MODE LEVEL:

User, Installer, Remote by PC

FACTORY DEFAULT:

User Code 1: 123

Installer Code: 000000

All other codes: [blank]

NOTES:

- User Codes can be 3 to 6 digits in length.
- User codes cannot start with '0'.
- All codes must be unique to each other.
- User Codes 2–15 can be programmed to be ARM ONLY codes.
- When programming a code you must enter it twice for verification.
- To clear an existing code, re-program that code with any number (not an existing code) beginning with 0.
- To clear all codes (except the Installer Code), enter P98E in Installer Program mode. See Page 53.
- Codes are rejected if already used. Some codes that are similar to existing codes may also be rejected.
- Open/Close reports are identified by user number when the control panel is base station monitored.

INSTALLER CODE NOTES:

- All of the above notes also apply to the Installer Code.

The function of the Installer Code is to gain access to Installer Program Mode.

See Page 13, "How To Enter Program Mode."

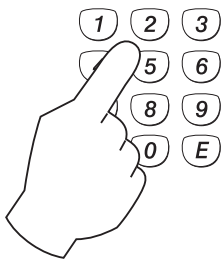

Radio Key programming,
Page 57

RADIO PROGRAMMING See pages 56,57

USER CODES

User codes are the 3 to 6 digit codes used to operate the panel by keypad.

User Codes 1–15: Used to arm/disarm the panel. These codes can also be programmed as Arm Only codes. User Code 1 is also the Master Code which is used to access Client Program mode.

PROGRAMMING SEQUENCE:

P[11–25]E the existing code is displayed
[ENTER NEW CODE] **E** [ENTER NEW CODE AGAIN] **E**
the new code is displayed

EXAMPLE: To program the Master Code

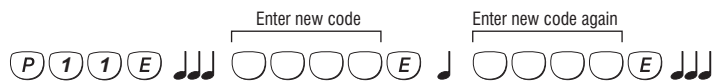

TO DELETE A CODE:

To delete a User Code, enter the MEMORY key in place of the code.

EXAMPLE: To delete User Code 2:

P12E MEMORY E

ARM ONLY CODES

User Codes 2–15 can be set as Arm Only Codes. These codes can Arm but cannot Disarm the panel.

When programming a code, enter ARM E in front of the code to enable the Arm Only option.

EXAMPLE: To program User Code 2 to be 1234 and an Arm Only code:

P12E ARM E 1234E 1234E

When the code is viewed, the ARMED icon is displayed before the digits of the code.

CODE TABLE

CODE	OPTION No	DESCRIPTION	FACTORY DEFAULT	ENABLE AS A RADIO CODE
User Code 1	P11E	Master Code	123	(Keypad Code only)
User Code 2	P12E			2E
User Code 3	P13E			3E
User Code 4	P14E			4E
User Code 5	P15E			5E
User Code 6	P16E			6E
User Code 7	P17E			7E
User Code 8	P18E			8E
User Code 9	P19E			1E
User Code 10	P20E			2E
User Code 11	P21E			3E
User Code 12	P22E			4E
User Code 13	P23E			5E
User Code 14	P24E			6E
User Code 15	P25E			7E
Installer Code	P99E	Installer Code	000000	

PROGRAMMING

OPTION No	DESCRIPTION	DEFAULT	NOTE
P26E	Entry Delay Time 1	20	Seconds
P27E	Entry Delay Time 2	6	x10 = 60 seconds
P28E	Exit Delay Time	60	Seconds
P29E	Siren Reset Time	5	Minutes

P26E

PROGRAM MODE LEVEL:

User, Installer, Remote by PC

FACTORY DEFAULT:

20 seconds

NOTES:

- Programmable from 1 – 99 seconds

ENTRY DELAY TIME1

The Entry Delay Time 1 is the time given to Disarm the Panel after a Entry Delay 1 zone is unsecured.

The Entry Delay Time1 setting is from 1 to 99 seconds.

PROGRAMMING SEQUENCE:

P26E existing time is displayed [ENTER NEW TIME] E new time is displayed

EXAMPLE: To program Entry Delay Time1 to be 30 seconds:

P26E 30E

P27E

PROGRAM MODE LEVEL:

User, Installer, Remote by PC

FACTORY DEFAULT:

60 seconds

NOTES:

- Programmable from 10 – 990 seconds

ENTRY DELAY TIME2

The Entry Delay Time2 is the time given to Disarm the panel after an Entry Delay2 zone is unsecured.

The Entry Delay Time2 setting is from 10 to 990 seconds (1 – 99).

Note: The Entry Delay Time2 is set in 10 second increments so that a value setting of 6 means a 60 seconds delay.

PROGRAMMING SEQUENCE:

P27E existing time is displayed [ENTER NEW TIME] E new time is displayed

EXAMPLE: To program Entry Delay Time2 to be 600 seconds:

P27E 60E

P28E

PROGRAM MODE LEVEL:

User, Installer, Remote by PC

FACTORY DEFAULT:

60 seconds

NOTES:

- Programmable from 1 – 99 seconds
- RELATED OPTIONS:
P62E 8E Exit Time x10

EXIT DELAY TIME

The Exit Delay Time is the time given to secure and depart the premises after the Panel is Armed. All zones (except 24hr zones) are inactive during the Exit Delay time.

The Exit Delay Time setting is from 1 to 99 seconds.

PROGRAMMING SEQUENCE:

P28E existing time is displayed [ENTER NEW TIME] E new time is displayed

EXAMPLE: To program Exit Delay to be 85 seconds:

P28E 85E

P29E

PROGRAM MODE LEVEL:

Installer, Remote by PC

FACTORY DEFAULT:

5 minutes

NOTES:

- Programmable from 1 – 99 minutes
- Siren times of longer than 5 minutes are contrary to noise pollution regulations in most areas.

SIREN RESET TIME

The Siren Reset Time sets the duration of the Siren and Reset outputs.

The Siren Reset Time setting is from 1 to 99 minutes.

PROGRAMMING SEQUENCE:

P29E existing time is displayed [ENTER NEW TIME] E new time is displayed

EXAMPLE: To program Siren Time to be 4 minutes:

P29E 4E

PROGRAMMING

P30E – P38E

PROGRAM MODE LEVEL:

Installer, Remote by PC

FACTORY DEFAULT:

Normal sensitivity.

P30E, all zones = ON

NOTES:

- Sensitivity can be individually programmed for each zone.
- Zones are allocated to one sensitivity level at any one time. Turning a zone ON in a sensitivity level, turns the zone OFF in any other sensitivity level.
- To revert zone sensitivity back to Normal. Turn the required zone/s ON at Option 30.
- Avoid using P31 and P38 sensitivity – they are provided as a guide to the upper and lower limits.

USING NESENSORS.

Nessensors are sensitive to high frequencies and insensitive to low frequencies. Therefore it is not necessary to apply much force to the protected structure, rather a very rapid succession of blows.

The sensitivity has been correctly adjusted when a single blow applied with a soft object (e.g. by hand) does not cause an alarm whereas a rapid series of blows (using a metal object such as a screw-driver blade) will cause an alarm.

VIBRATION SENSITIVITY

Each zone has individually adjustable sensitivity for connection of Nessensor Vibration Sensors.

Zone sensitivity is adjusted by toggling zones ON in options P30E to P38E.

P30E, Normal Sensitivity– vibration analyser disabled. This is used for normal alarm devices. Zone response time, 200ms.

P31–38E are the options for the 8 levels of vibration sensitivities. P31E is the most sensitive setting.

PROGRAMMING SEQUENCE:

P [30–38] E zones are displayed [Zone No] E

EXAMPLE: To program zones 2 and 3 to be Medium Sensitivity:

P34E 2E 3E the keypad display will show zone lights 2 & 3 to be ON

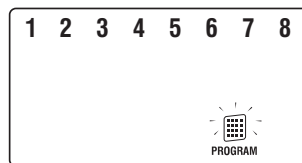

Factory Default Setting for P30E.
All zones selected ON = Normal sensitivity.

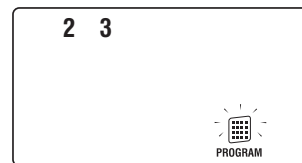

Example P34E: Zones 2 & 3 are Medium sensitivity.

VIBRATION SENSITIVITY

OPTION No	SENSITIVITY	Zones							
		1	2	3	4	5	6	7	8
P30E	Normal	ON	ON	ON	ON	ON	ON	ON	ON
P31E	High								
P32E									
P33E									
P34E									
P35E									
P36E									
P37E									
P38E	Low								

ON = Factory default setting

Ness NESSENSOR Vibration sensor Part No. VIB100

In addition to zone sensitivity adjustment, the overall sensitivity of the Nesssensor can be adjusted by rotating the body of the Nesssensor within its bracket.

The bracket must always be mounted horizontally and the arrow must point up for any required setting.

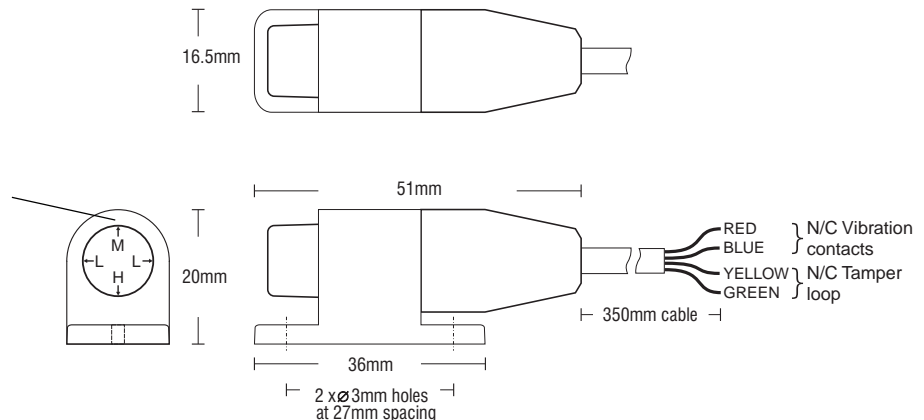

PROGRAMMING

ZONE ASSIGNMENT

OPTION No	DESCRIPTION	Zones							
		1	2	3	4	5	6	7	8
P39E	Double Trigger zones								
P40E	Instant zones			ON	ON	ON	ON	ON	ON
P41E	Entry Delay 1 zones	ON							
P42E	Handover zones		ON						
P43E	Entry Delay 2 zones								
P44E	Lockout zones	ON	ON	ON	ON	ON	ON	ON	ON
P45E	Area 1 zones	ON	ON	ON	ON	ON	ON	ON	ON
P46E	Area 2 zones								
P51E	Monitor zones								
P52E	24Hr zones								
P53E	Day zones								

DELAY GROUP
Only one option allowed per zone

ON = Factory default setting

P39E

PROGRAM MODE LEVEL:
Installer, Remote by PC

FACTORY DEFAULT:
all OFF: No Double Trigger zones

NOTES:

- Double Trigger is useful for preventing unwanted alarms from zones in harsh environments such as sheds and garages.
- **0E** will turn all selections OFF
MEMORY E will turn all selections ON

DOUBLE TRIGGER ZONES

Zones programmed to Double Trigger will recognise an alarm condition if:

- The zone has been triggered twice within a 4 minute period.
- If any 2 zones (both programmed for double trigger), each trigger once.
- The zone is left unsealed for longer than 15 seconds.

PROGRAMMING SEQUENCE:

P39E [Zone No]E toggles the options ON and OFF

P39E [Zone No]E OFF: The zone is not a Double Trigger zone

P39E [Zone No]E ON: The zone is a Double Trigger zone

P40E

PROGRAM MODE LEVEL:
Installer, Remote by PC

FACTORY DEFAULT:
3E–8E ON: Zones 3~8 are Instant

NOTES:

- When a zone is selected for this type, it is automatically deselected from any other zone type in the DELAY GROUP

INSTANT ZONES

Instant Zones operate only in the Armed state. When Armed at the expiry of exit time, Instant Zones will activate assigned outputs immediately when triggered.

P40E [Zone No]E turns the options ON

P40E [Zone No]E ON: The zone is an Instant Zone

To deselect the option, select a different zone type in the DELAY GROUP.

P41E

PROGRAM MODE LEVEL:
Installer, Remote by PC

FACTORY DEFAULT:
1E ON: Zone 1 has Entry Delay1

NOTES:

- The keypad sonalert will beep during Entry Delay as a reminder to disarm the panel. Entry beeps can be disabled by program option P60E 1E.
- When a zone is selected for this type, it is automatically deselected from any other zone type in the DELAY GROUP

ENTRY DELAY1 ZONES

Entry Delay1 zones operate only in the Armed state. When Armed, at the expiry of exit time these zones will activate the Entry Delay Timer1 (P26E) when they are triggered. If the panel is not disarmed before the expiry of the Entry Delay Timer1, the alarm outputs will be activated.

P41E [Zone No]E turns the options ON

P41E [Zone No]E ON: The zone is an Entry Delay1 zone

To deselect the option, select a different zone type in the DELAY GROUP.

PROGRAMMING

P42E

PROGRAM MODE LEVEL:

Installer, Remote by PC

FACTORY DEFAULT:

2E ON: Zone 2 is a Handover zone

NOTES:

- When a zone is selected for this type, it is automatically deselected from any other zone type in the DELAY GROUP

P43E

PROGRAM MODE LEVEL:

Installer, Remote by PC

FACTORY DEFAULT:

all OFF: No zones have Entry Delay2

NOTES:

- When a zone is selected for this type, it is automatically deselected from any other zone type in the DELAY GROUP

P44E

PROGRAM MODE LEVEL:

Installer, Remote by PC

FACTORY DEFAULT:

all ON: All zones are Lockout zones

NOTES:

- The SIREN output always locks out
- **0E** will turn all selections OFF
MEMORY E will turn all selections ON
- RELATED OPTIONS:
P60E 4E Tamper Reset Lockout

P45E, P46E

P47E – P50E

HANDOVER ZONES

Handover zones are delayed only if entry is made through an Entry Delay zone first. If a Handover zone is triggered first, the zone behaves as an instant zone. Normally, the “point of entry” zone should be Delay zone, with any other zones in the entry path programmed as Handover zones.

PROGRAMMING SEQUENCE:

P42E [Zone No]E turns the options ON

P42E [Zone No]E ON: The zone is a Handover zone

To deselect the option, select a different zone type in the DELAY GROUP.

ENTRY DELAY2 ZONES

When an Entry Delay2 zone is triggered, it has entry delay as set by the Entry Delay Time2 (P27E).

PROGRAMMING SEQUENCE:

P43E [Zone No]E turns the options ON

P43E [Zone No]E ON: The zone is an Entry Delay2 zone

To deselect the option, select a different zone type in the DELAY GROUP.

RESET LOCKOUT ZONES

All 8 zones and tamper input can be programmed to Lockout, i.e. cause the RESET OUTPUT to sound only once whilst the panel is armed.

The RESET OUTPUT is then locked out for that alarmed zone until entering a valid code has reset the panel.

PROGRAMMING SEQUENCE:

P44E [Zone No]E toggles the options ON and OFF

P44E [Zone No]E OFF: The zone is not a Lockout zone

P44E [Zone No]E ON: The zone is a Lockout zone

AREA PARTITIONING

See page 20

ASSIGNING USER CODES TO AREAS

See page 21

PROGRAMMING

P51E

PROGRAM MODE LEVEL:

Installer, Remote by PC

FACTORY DEFAULT:

all OFF: No Monitor zones

NOTES:

- RELATED OPTIONS:
 - P63E** Monitor Mode output mapping
 - P64E 1E** 2 second Monitor Mode alarm
 - P64E 3E** Monitor zones have Entry Delay2

P52E

PROGRAM MODE LEVEL:

Installer, Remote by PC

FACTORY DEFAULT:

all OFF: No 24hr zones

NOTES:

- The Tamper input is always a 24hr zone
- For silent 24hr zones, simply deselect the zone/s from options P54E–P57E (Reset, Strobe, Sonalert & Siren)
- **To change a 24hr zone to any other zone type, the zone must also be re-assigned to an AREA (P45E or P46E).**

24hr zones are independent of Area operation. All other zone types must be assigned to at least one Area to become active.

P53E

PROGRAM MODE LEVEL:

Installer, Remote by PC

FACTORY DEFAULT:

all OFF: No Day zones

NOTES:

- RELATED OPTIONS:
 - P63E 5E–8E** Day zone output mapping
 - P64E 2E** 2 sec Day Mode alarm
- TYPICAL USES:
 - Instant alert when a delivery door is opened.
 - Doorway alert for a shop. Turn ON option **P63E 7E** for keypad sonalert when a Day zone alarms.

MONITOR ZONES

Monitor zones allow you to Arm selected zones while others are ignored. Typically used for perimeter zones such as windows and doors while you are at home. Example: Upstairs zones are Disarmed while downstairs zones are Armed in Monitor mode.

PROGRAMMING SEQUENCE:

P51E [Zone No]E toggles the options ON and OFF

P51E [Zone No]E OFF: The zone is not a Monitor zone

P51E [Zone No]E ON: The zone is a Monitor zone

24hr ZONES

24hr Zones operate at all times regardless of the mode of panel operation, i.e. Armed, Disarmed or Monitor. When alarmed, these zones will activate assigned outputs immediately. To reset those alarms a valid user code must be entered.

Selecting a zone as 24hr will override any other zone type setting such as Instant, Delayed or Handover.

PROGRAMMING SEQUENCE:

P52E [Zone No]E toggles the options ON and OFF

P52E [Zone No]E OFF: The zone is not a 24hr zone

P52E [Zone No]E ON: The zone is a 24hr zone

DAY ZONES

Day Zones operate when the panel is fully disarmed, i.e. when Area 1, Area 2 and Monitor are all off. When alarmed, these zones will activate the assigned outputs instantly.

The outputs mapped to the Day Zone will turn on while the zone is unsealed. Turn P64E 2E on, to limit Day Zone alarms to 2 seconds.

PROGRAMMING SEQUENCE:

P53E [Zone No]E toggles the options ON and OFF

P53E [Zone No]E OFF: The zone is not a Day zone

P53E [Zone No]E ON: The zone is a Day zone

PROGRAMMING

AREA PARTITIONING

DEFINITION

Area Partitioning allows the 8 zones to be split into two partitions; Area1 and Area2.

The panel then effectively operates as two separate systems sharing only the siren outputs and dialler.

USER CODE ASSIGNMENT

A User Code assigned to an Area can Arm and Disarm only that Area. User Codes assigned to both Areas will operate both Areas simultaneously.

COMMON AREA ZONES

Zones assigned to both Areas are armed only when Area1 and Area2 are both armed. This allows the Common Area zone/s to be shared by both Areas.

For example, Office A and Office B operate as separate areas but the entrance foyer used by both offices is assigned to *both* areas meaning it will automatically Arm when both Areas have Armed. The Common Area then automatically disarms when either Area1 or Area2 Disarms.

OPERATION

Arming and Disarming is carried out as normal from a single keypad or separate keypads installed in both areas or by Radio Key.

Area operation only applies to zones when they are in the armed state. This means that Day, 24hr and Monitor zones are independent of the area operations.

Note: Area partitioning is in addition to Monitor Mode. Any zone may be allocated to any area.

OPTION No	DESCRIPTION	Zones							
		1	2	3	4	5	6	7	8
P45E	Area 1 zones	ON	ON	ON	ON	ON	ON	ON	ON
P46E	Area 2 zones								

ON = Factory default setting

P45E, P46E

PROGRAM MODE LEVEL:

Installer, Remote by PC

FACTORY DEFAULT:

No zones assigned to Area 2.

NOTES:

- For options P45E and P46E, **[Zone No] E** toggles the selection ON and OFF.
- Zones assigned to BOTH areas become Common zones.
- If no Area operation is required, assign all zones to Area 1. (This is also the factory default).

ASSIGNING ZONES TO AREAS

Assign (or remove) zones that will operate when Area 2 is armed.

PROGRAMMING SEQUENCE:

P45E [Zone No]E toggles the options ON and OFF for Area1

P45E [Zone No]E OFF: The zone is not in Area1

P45E [Zone No]E ON: The zone is in Area1

P46E [Zone No]E toggles the options ON and OFF for Area2

P46E [Zone No]E OFF: The zone is not in Area2

P46E [Zone No]E ON: The zone is in Area2

EXAMPLE:

To program zones 1~4 for Area 1 and zones 1, 5~8 for Area 2. In this example, we have assigned zone 1 to both areas, so it becomes a Common Zone.

P45E use the **[Zone No] E** sequence to turn ON only zones 1~4.

P46E use the **[Zone No] E** sequence to turn ON zone 1 and zones 5~8.

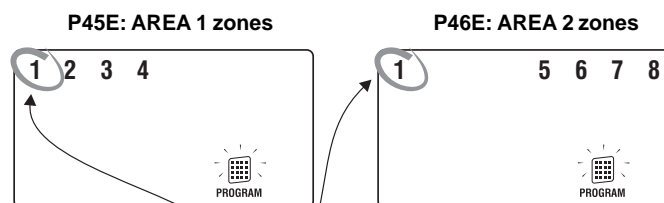

Example:
Zone 1 is assigned to both Areas, so it is a **Common Zone**

PROGRAMMING

OPTION No	DESCRIPTION	1E	2E	3E	4E	5E	6E	7E	8E
P47E	Codes 1-8 to AREA1	ON	ON	ON	ON	ON	ON	ON	ON
P49E	Codes 1-8 to AREA2	ON							

ON = Factory default setting.

OPTION No	DESCRIPTION	1E	2E	3E	4E	5E	6E	7E
P48E	Codes 9-15 to AREA1	ON	ON	ON	ON	ON	ON	ON
P50E	Codes 9-15 to AREA2							

P47E, P48E

DESCRIPTION:

Area 1 User Codes

PROGRAM MODE LEVEL:

Installer, Remote by PC

FACTORY DEFAULT:

All User Codes assigned to Area 1

P49E, P50E

DESCRIPTION:

Area 2 User Codes

PROGRAM MODE LEVEL:

Installer, Remote by PC

FACTORY DEFAULT:

User Code 1 (Master Code) assigned to Area 2.

NOTES:

- User Codes can be assigned to either a single Area or to both Areas.
- If a User Code is assigned to NO Areas, the code is effectively disabled and will not operate the panel.
- To make a User Code arm or disarm just one Area, assign that code only to the required Area.
- Assigning User Codes to Areas has no effect unless zones are also assigned to Areas.
- For this option **[Zone No] E** toggles the selection ON and OFF.

ASSIGNING USER CODES TO AREAS

Assign (or remove) User Codes to Areas.

PROGRAMMING SEQUENCE:

P47E 1E-8E toggles the options ON and OFF

Assigns User Codes 1-8 to **AREA1**

P48E 1E-7E toggles the options ON and OFF

Assigns User Codes 9-15 to **AREA1**

P49E 1E-8E toggles the options ON and OFF

Assigns User Codes 1-8 to **AREA2**

P50E 1E-7E toggles the options ON and OFF

Assigns User Codes 9-15 to **AREA2**

EXAMPLE:

To assign User Codes 1-8 to AREA1 and User Codes 9-15 to AREA2.

P47E turn ON lights 1-8

P48E turn OFF lights 1-7

P49E turn OFF lights 1-8

P50E turn ON lights 1-7

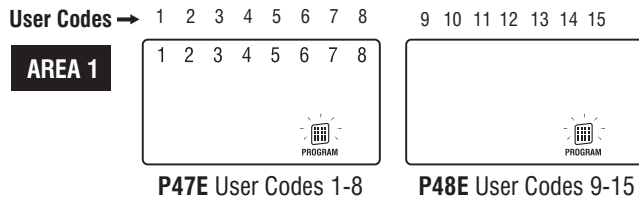

EXAMPLE:

User codes 1-8 are assigned to AREA 1.

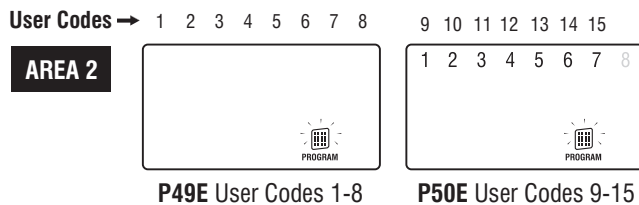

EXAMPLE:

User codes 9-15 are assigned to AREA 2.

PROGRAMMING

ZONE TO OUTPUT MAPPING

When a zone alarms, it can turn on any or all of the following 6 outputs: Sonalert, Strobe, Siren, Reset, AUX1, AUX2.

The programming is selected with options P54E – P59E. Simply set the zone number to the output to select it. The zone LED will indicate if the zone is selected.

The Tamper Input and the Keypad Panic can be programmed to turn on the Reset, Strobe, Sonalert and Siren by using option P61E.

ZONE TO OUTPUTS MAPPING

OPTION No	DESCRIPTION	Zones							
		1	2	3	4	5	6	7	8
P54E	Reset zones	ON	ON	ON	ON	ON	ON	ON	ON
P55E	Strobe zones	ON	ON	ON	ON	ON	ON	ON	ON
P56E	Sonalert zones	ON	ON	ON	ON	ON	ON	ON	ON
P57E	Siren zones	ON	ON	ON	ON	ON	ON	ON	ON
P58E	Aux1 zones	ON	ON	ON	ON	ON	ON	ON	ON
P59E	Aux2 zones	ON	ON	ON	ON	ON	ON	ON	ON

ON = Factory default setting

NOTE: Zone To Output Mapping applies to zones when the panel is in the Armed or 24hr state.

For MONITOR and DAY mode Output Mapping – see Option P63E 1E–8E, page 28

P51~P53E, page 19

P54E

PROGRAM MODE LEVEL:

Installer, Remote by PC

FACTORY DEFAULT:

all ON: All zones trigger Reset output

NOTES:

- **0E** will turn all selections OFF
- **MEMORY E** will turn all selections ON

P55E

PROGRAM MODE LEVEL:

Installer, Remote by PC

FACTORY DEFAULT:

all ON: All zones trigger Strobe output

NOTES:

- **0E** will turn all selections OFF
- **MEMORY E** will turn all selections ON

P56E

PROGRAM MODE LEVEL:

Installer, Remote by PC

FACTORY DEFAULT:

all ON: All zones trigger Keypad Sonalert

NOTES:

- **0E** will turn all selections OFF
- **MEMORY E** will turn all selections ON

RESET OUTPUT ZONES

Selects the zones to trigger the Reset output.

PROGRAMMING SEQUENCE:

P54E [Zone No]E toggles the options ON and OFF

P54E [Zone No]E OFF: The zone will not trigger the Reset output

P54E [Zone No]E ON: The zone will trigger the Reset output

STROBE OUTPUT ZONES

Selects the zones to trigger the Strobe output.

PROGRAMMING SEQUENCE:

P55E [Zone No]E toggles the options ON and OFF

P55E [Zone No]E OFF: The zone will not trigger the Strobe output

P55E [Zone No]E ON: The zone will trigger the Strobe output

KEYPAD SONALERT ZONES

Selects the zones to trigger the Keypad Sonalert (beeper).

PROGRAMMING SEQUENCE:

P56E [Zone No]E toggles the options ON and OFF

P56E [Zone No]E OFF: The zone will not trigger the Keypad Sonalert

P56E [Zone No]E ON: The zone will trigger the Keypad Sonalert

PROGRAMMING

P57E

PROGRAM MODE LEVEL:

Installer, Remote by PC

FACTORY DEFAULT:

all ON: All zones trigger Siren output

NOTES:

- **OE** will turn all selections OFF
MEMORY E will turn all selections ON

P58E

PROGRAM MODE LEVEL:

Installer, Remote by PC

FACTORY DEFAULT:

all OFF: No zones trigger AUX1

NOTES:

- **OE** will turn all selections OFF
MEMORY E will turn all selections ON

P59E

PROGRAM MODE LEVEL:

Installer, Remote by PC

FACTORY DEFAULT:

all OFF: No zones trigger AUX2

NOTES:

- **OE** will turn all selections OFF
MEMORY E will turn all selections ON

SIREN OUTPUT ZONES

Selects the zones to trigger the Siren output.

PROGRAMMING SEQUENCE:

P57E [Zone No]E toggles the options ON and OFF

P57E [Zone No]E OFF: The zone will not trigger the Siren output

P57E [Zone No]E ON: The zone will trigger the Siren output

AUX1 OUTPUT ZONES

Selects the zones to trigger the AUX1 output. AUX1 output is Pin1 on the J3 header on the main board.

PROGRAMMING SEQUENCE:

P58E [Zone No]E toggles the options ON and OFF

P58E [Zone No]E OFF: The zone will not trigger the AUX1 output

P58E [Zone No]E ON: The zone will trigger the AUX1 output

AUX2 OUTPUT ZONES

Selects the zones to trigger the AUX2 output. AUX2 output is Pin2 on the J3 header on the main board.

PROGRAMMING SEQUENCE:

P59E [Zone No]E toggles the options ON and OFF

P59E [Zone No]E OFF: The zone will not trigger the AUX2 output

P59E [Zone No]E ON: The zone will trigger the AUX2 output

PROGRAMMING

OPTION No	DESCRIPTION	1E	2E	3E	4E	5E	6E	7E	8E
P60E	Various options	ON			ON		ON		

Entry beeps
 Keysw Monitor/Disarm
 Keysw/Arm/Disarm
 Tamper siren lockout
 Duress to Reset output
 Auto Exclude zones
 Auto KP display off
 Delay AREA1-2 outputs

ON = Factory default setting.

P60E 1E

PROGRAM MODE LEVEL:
 Installer, Remote by PC

FACTORY DEFAULT:
 Entry Beeps ON

NOTES:

ENTRY BEEPS

The sionalert will beep during Entry Delay.

PROGRAMMING SEQUENCE:

P60E 1E toggles the option ON and OFF

P60E 1E OFF: Entry Beeps OFF

P60E 1E ON: Entry Beeps ON

P60E 2E, 3E

PROGRAM MODE LEVEL:
 Installer, Remote by PC

FACTORY DEFAULT:
 No keyswitch enabled

NOTES:

- The keyswitch always Arms Area1 only.
- The keyswitch always Disarms Area1 and Area2.
- Momentary short circuit across resistor to toggle panel modes.
- Open circuit resistor to trigger keyswitch panic.
- Multiple keyswitches can be used. Wire in parallel.

KEYSWITCH MONITOR MODE ARMING

An externally fitted, normally open momentary Keyswitch can be used to Arm, Disarm or change the D8 to Monitor mode.

The keyswitch is wired to zone 8 (zone 8 is then no longer available as a normal alarm input, but IS still available for use as a Radio Zone).

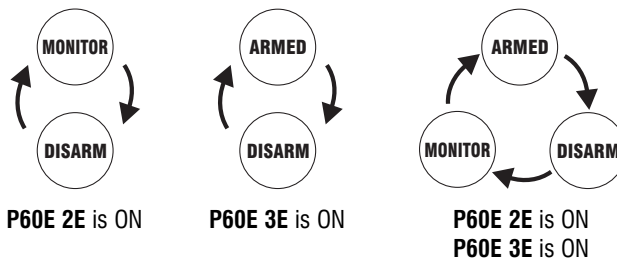

PROGRAMMING SEQUENCE:

P60E 2E or 3E toggles the option ON and OFF

P60E 2E & 3E OFF: No keyswitch operation. Zone 8 is a normal alarm input.

P60E 2E ON: Keyswitch cycles between Monitor and Disarm.

P60E 3E ON: Keyswitch cycles between Arm and Disarm.

P60E 2E & 3E ON: Keyswitch cycles between Arm, Monitor and Disarm.

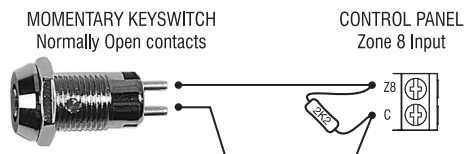

PROGRAMMING

P60E 4E

PROGRAM MODE LEVEL:

Installer, Remote by PC

FACTORY DEFAULT:

ON: Tamper Reset Lockout enabled

NOTES:

RELATED OPTIONS:

P44E Lockout zones

P60E 5E

PROGRAM MODE LEVEL:

Installer, Remote by PC

FACTORY DEFAULT:

OFF: No Reset output on Duress alarm

NOTES:

- To Disarm with Duress, add any of the digits 5,6,8 or 9 in front of the User Code when disarming.

P60E 6E

PROGRAM MODE LEVEL:

Installer, Remote by PC

FACTORY DEFAULT:

ON: Auto Exclude enabled

NOTES:

RELATED OPTIONS:

- P62E 7E Siren burst on Auto Exclude

P60E 7E

PROGRAM MODE LEVEL:

Installer, Remote by PC

FACTORY DEFAULT:

OFF: Display is always ON

NOTES:

- On the LCD keypad, the display and display backlighting will turn off but the keys backlighting will remain on. The keypad flap can be closed to reduce stray light from the keys.

P60E 8E

PROGRAM MODE LEVEL:

Installer, Remote by PC

FACTORY DEFAULT:

OFF: ARM1 & ARM2 outputs are instant

NOTES:

TAMPER ALARM LOCKOUT

This option programs the Tamper input to Lockout, i.e. cause the Siren & Reset outputs to sound only once whilst the panel is armed.

PROGRAMMING SEQUENCE:

P60E 4E toggles the option ON and OFF

P60E 4E OFF: Tamper Reset Lockout disabled

P60E 4E ON: Tamper Reset Lockout enabled

DURESS TO RESET OUTPUT

Keypad Duress is normally a silent alarm. This option makes the Duress alarm trigger the Reset output.

PROGRAMMING SEQUENCE:

P60E 5E toggles the option ON and OFF

P60E 5E OFF: No Reset output on Duress alarm

P60E 5E ON: Duress alarm triggers Reset output

AUTO EXCLUDE ZONES

If a zone is unsealed at the end of Exit Time the panel can either Exclude (ignore) that zone or immediately alarm.

The panel will give a 2 second Siren burst at the end of Exit Time to indicate that the panel is armed with a zone/s Auto Excluded. The 2 sec Siren burst can be disabled by option P62E 7E.

PROGRAMMING SEQUENCE:

P60E 6E toggles the option ON and OFF

P60E 6E OFF: Auto Exclude disabled (instant alarm if unsealed at end of Exit Time)

P60E 6E ON: Auto Exclude enabled (zone is excluded if unsealed at end of Exit Time)

DISABLE THE DISPLAY

The LED indicators on the keypad can be programmed to blank after 4 minutes of no keypad use. Any action that causes a beep will restore the display (Use the **(E)** button preferably).

PROGRAMMING SEQUENCE:

P60E 7E toggles the option ON and OFF

P60E 7E OFF: Display is always on

P60E 7E ON: Display will blank after 4 minutes

DELAY ARM1 & ARM2 OUTPUTS

The output ARM1 turns on when Area 1 is armed. The output ARM2 turns on when Area 2 is armed. These outputs can be programmed to turn on instantly or at the end of Exit Time

ARM1 & ARM2 output s are Pins 3 & 4 on the J3 header on the main board.

PROGRAMMING SEQUENCE:

P60E 8E toggles the option ON and OFF

P60E 8E OFF: ARM1 & ARM2 outputs turn on instantly

P60E 8E ON: ARM1 & ARM2 outputs turn on at end of Exit Time

PROGRAMMING

Tamper to Reset output
 Tamper to Strobe output
 Tamper to Sonalert
 Tamper to Siren output
 KP Panic to Reset output
 KP Panic to Strobe output
 KP Panic to Sonalert
 KP Panic to Siren output

OPTION No	DESCRIPTION	1E	2E	3E	4E	5E	6E	7E	8E
P61E	Tamper & Panic alarms mapping	ON	ON	ON	ON	ON	ON	ON	ON

ON = Factory default setting.

P61E 1E-4E

PROGRAM MODE LEVEL:
 Installer, Remote by PC

FACTORY DEFAULT:
 1E-4E, ON: Tamper alarm triggers all outputs

- NOTES:**
- A Tamper Alarm can be caused by the TAMP input or by removing the the J1 link.

TAMPER ALARM / OUTPUT MAPPING

This option selects which outputs will trigger when a Tamper Alarm occurs.

PROGRAMMING SEQUENCE:

P61E 1E-4E toggles the options ON and OFF

- P61E 1E: Tamper Alarm to Reset output
- P61E 2E: Tamper Alarm to Strobe output
- P61E 3E: Tamper Alarm to Keypad Sonalert output
- P61E 4E: Tamper Alarm to Siren output

P61E 5E-8E

PROGRAM MODE LEVEL:
 Installer, Remote by PC

FACTORY DEFAULT:
 5E-8E, ON: Panic alarm triggers all outputs

- NOTES:**
- A Keypad Panic Alarm can be caused by the PANIC keys on the keypad (* E or ** together, depending on Option P64E6E).

KEYPAD PANIC ALARM / OUTPUT MAPPING

This option selects which outputs will trigger when a Keypad Panic alarm occurs.

PROGRAMMING SEQUENCE:

P61E 5E-8E toggles the options ON and OFF

- P61E 5E: Keypad Panic Alarm to Reset output
- P61E 6E: Keypad Panic Alarm to Strobe output
- P61E 7E: Keypad Panic Alarm to Keypad Sonalert output
- P61E 8E: Keypad Panic Alarm to Siren output

PROGRAMMING

Shortcut Memory Display
 Shortcut Zone Exclude
 Shortcut Monitor Mode
 Shortcut Keypad Panic
 Shortcut Area1 Arming
 Shortcut Area2 Arming
 2 sec Siren Auto Exclude
 Exit Time x10

OPTION No	DESCRIPTION	1E	2E	3E	4E	5E	6E	7E	8E
P62E	Operation Shortcuts, etc	ON	ON	ON		ON		ON	

ON = Factory default setting.

P62E 1E-6E

PROGRAM MODE LEVEL:

Installer, Remote by PC

FACTORY DEFAULT:

- 1E, ON: Memory Display shortcut enabled
- 2E, ON: Zone Exclude shortcut enabled
- 3E, ON: Monitor Mode shortcut enabled
- 4E, OFF: Keypad Panic disabled
- 5E, ON: Area1 Arming shortcut enabled
- 6E, OFF: Area2 Arming shortcut disabled

NOTES:

- A Tamper Alarm can be caused by the TAMP input or the J1 link.
- Allocate a User Code to Area2 before programming Area2 shortcut arming. If Area 2 is shortcut armed then it will always remain armed. This will bar entry into program mode until Area 2 is disarmed.

P62E 7E

PROGRAM MODE LEVEL:

Installer, Remote by PC

FACTORY DEFAULT:

ON: Siren burst on Auto Exclude enabled

NOTES:

- RELATED OPTIONS:
P60E 6E Auto Exclude zones

P62E 8E

PROGRAM MODE LEVEL:

Installer, Remote by PC

FACTORY DEFAULT:

OFF: Exit Time x10 disabled

NOTES:

- RELATED OPTIONS:
P28E Exit Time

SYSTEM OPERATION SHORTCUTS

Some keypad operations can be programmed to operate with or without a User Code.

PROGRAMMING SEQUENCE:

P62E 1E-6E toggles the options ON and OFF

- P62E 1E Memory Display shortcut
- P62E 2E Zone Exclude shortcut
- P62E 3E Monitor Mode shortcut
- P62E 4E Keypad Panic shortcut
- P62E 5E Area1 Arming shortcut
- P62E 6E Area2 Arming shortcut

OPERATING EXAMPLES:

Arming without shortcut: (ARM) [User Code] (E)

Arming with shortcut: (ARM) (E)

Keypad Panic without shortcut: (*) [User Code] (E)

Keypad Panic with shortcut: (*) (E)

SIREN BURST ON AUTO EXCLUDE

This option allows the disabling of the 2 second siren burst at end of Exit Time which indicates a zone/s has been Auto Excluded.

PROGRAMMING SEQUENCE:

P62E 7E toggles the option ON and OFF

- P62E 7E OFF: Siren burst on Auto Exclude disabled
- P62E 7E ON: Siren burst on Auto Exclude enabled

EXIT TIME X10

This option multiplies the normal exit time by a factor of 10.

PROGRAMMING SEQUENCE:

P62E 8E toggles the option ON and OFF

- P62E 8E OFF: Exit Time is the time set by P28E
- P62E 8E ON: Exit Time is multiplied by 10

EXAMPLE: If P28E = 22 seconds then if P62E 8E is ON, the exit time is 22 x 10 = 220 seconds.

PROGRAMMING

Monitor to Reset output
 Monitor to Strobe output
 Monitor to Sonalert output
 Monitor to Siren output
 Day Mode to Reset output
 Day Mode to Strobe output
 Day Mode to Sonalert output
 Day Mode to Siren output

OPTION No	DESCRIPTION	1E	2E	3E	4E	5E	6E	7E	8E
P63E	Monitor & Day mode output mapping					ON	ON		

ON = Factory default setting.

P63E 1E-4E

PROGRAM MODE LEVEL:

Installer, Remote by PC

FACTORY DEFAULT:

1E-4E OFF: No Monitor Mode outputs

NOTES:

- RELATED OPTIONS:
P64E 1E 2second Monitor alarm

MONITOR MODE OUTPUT MAPPING

This option selects which outputs are triggered by alarms in Monitor Mode.

PROGRAMMING SEQUENCE:

P63E 1E-4E toggles the options ON and OFF

P63E 1E: Monitor Mode to Reset output

P63E 2E: Monitor Mode to Strobe output

P63E 3E: Monitor Mode to Keypad Sonalert output

P63E 4E: Monitor Mode to Siren output

P63E 5E-8E

PROGRAM MODE LEVEL:

Installer, Remote by PC

FACTORY DEFAULT:

5E, 6E ON

7E, 8E OFF

NOTES:

- RELATED OPTIONS:
P64E 2E 2second Day alarm

DAY MODE OUTPUT MAPPING

This option selects which outputs are triggered by alarms in Day Mode.

PROGRAMMING SEQUENCE:

P63E 5E-8E toggles the options ON and OFF

P63E 5E: Day Mode to Reset output

P63E 6E: Day Mode to Strobe output

P63E 7E: Day Mode to Keypad Sonalert output

P63E 8E: Day Mode to Siren output



MONITOR Mode and DAY Mode Output Mapping is an extra feature released with the D8 V4.

Note that MONITOR and DAY zones do not automatically assume the outputs assigned by Options P54E-P59E. Those options only apply to zones when the panel is in the ARMED state.

Options P63E 1E-8E allow different outputs to be triggered when the panel is in MONITOR and DAY modes.

For ZONE TO OUTPUT MAPPING (Armed & 24hr states)

– see Options P54E – P59E, page 22

PROGRAMMING

2 second Monitor Alarm
 2 second Day Alarm
 Monitor zones Entry2
 Radio Key chirp & flash
 50Hz mains frequency
 Double Key Keypad Panic
 Keypad Fire Alarm
 Keypad Medical Alarm

OPTION No	DESCRIPTION	1E	2E	3E	4E	5E	6E	7E	8E
P64E	Miscellaneous options		ON	ON		ON	ON		

ON = Factory default setting.

P64E 1E

PROGRAM MODE LEVEL:

Installer, Remote by PC

FACTORY DEFAULT:

OFF: Monitor Mode outputs normal time

NOTES:

- RELATED OPTIONS:
 - P51E Set Monitor zones
 - P63E 1E-4E Monitor Mode output mapping

P64E 2E

PROGRAM MODE LEVEL:

Installer, Remote by PC

FACTORY DEFAULT:

ON: 2 secDay Mode outputs

NOTES:

- RELATED OPTIONS:
 - P53E Assign Day zones
 - P63E 5E-8E Day Mode output mapping

P64E 3E

PROGRAM MODE LEVEL:

Installer, Remote by PC

FACTORY DEFAULT:

ON: Monitor zones all have Entry Delay2

NOTES:

- RELATED OPTIONS:
 - P27E Entry Delay Time 2
 - P51E Assign Monitor zones
 - P63E 1E-4E Monitor Mode output mapping

P64E 4E

PROGRAM MODE LEVEL:

Installer, Remote by PC

FACTORY DEFAULT:

OFF: No chirps

NOTES:

- RELATED OPTIONS:
 - P68E 8E Quiet Chirps

2 SECOND MONITOR MODE ALARM

Alarms in Monitor Mode can either activate the programmed outputs for Siren Time duration (P29E) or they can activate the outputs for 2 seconds only.

PROGRAMMING SEQUENCE:

P64E 1E toggles the option ON and OFF

P64E 1E OFF: Monitor Mode outputs have normal time as set by P29E

P64E 1E ON: Monitor Mode outputs are ON for 2 seconds only

2 SECOND DAY MODE ALARM

Alarms in Day Mode will activate the programmed outputs while the zone is unsealed or they can activate the outputs for 2 seconds only.

PROGRAMMING SEQUENCE:

P64E 2E toggles the option ON and OFF

P64E 2E OFF: Day Mode outputs are ON while the zone is unsealed

P64E 2E ON: Day Mode outputs are ON for 2 seconds only

MONITOR ZONES ENTRY DELAY2

Monitor zones can either have the delay types set by options P40E-P43E or they can all be assigned to have Entry Delay 2. This allows all Monitor zones to be programmed with the same entry delay time.

PROGRAMMING SEQUENCE:

P64E 3E toggles the option ON and OFF

P64E 3E OFF: Monitor zones behave as programmed by P40E-P43E

P64E 3E ON: Monitor zones all have Entry Delay2

ARM/DISARM CHIRPS

If this option is selected the Siren and Strobe Outputs will "Chirp" when the panel is Armed and Disarmed with the Keyswitch or Radio Keys.

The panel will make 1 Chirp on Arming, and 3 Chirps on Disarming.

PROGRAMMING SEQUENCE:

P64E 4E toggles the option ON and OFF

P64E 4E OFF: No Arm/Disarm chirps

P64E 4E ON: Siren & Strobe outputs will chirp on arm/disarm

PROGRAMMING

P64E 5E

PROGRAM MODE LEVEL:

Installer, Remote by PC

FACTORY DEFAULT:

ON: 50Hz mains frequency

NOTES:

50Hz MAINS FREQUENCY

Selects either 50Hz or 60Hz mains power frequency operation. Leave the factory default for use in Australia and New Zealand. Users in North America should select 60Hz mains frequency.

Required for the accurate timing of dialler test reports (if programmed). It has no effect on local or other dialler operations.

PROGRAMMING SEQUENCE:

P64E 5E toggles the option ON and OFF

P64E 5E OFF: 60Hz mains frequency

P64E 5E ON: 50Hz mains frequency

P64E 6E

PROGRAM MODE LEVEL:

Installer, Remote by PC

FACTORY DEFAULT:

ON: Double key Keypad Panic enabled

NOTES:

- RELATED OPTIONS:
 - P62E 4E** Shortcut Keypad Panic
- The Ness LCD keypad has two buttons labelled 

DOUBLE KEY KEYPAD PANIC

This option allows the Keypad Panic alarm to be triggered by pressing both  Panic buttons together.

NOTE:  **[User Code]**  always triggers Keypad Panic

PROGRAMMING SEQUENCE:

P64E 6E toggles the option ON and OFF

P64E 6E OFF: No double key Keypad Panic

P64E 6E ON: Double key Keypad Panic enabled

P64E 7E

PROGRAM MODE LEVEL:

Installer, Remote by PC



FACTORY DEFAULT:

OFF: No Keypad Fire Alarm

NOTES:

- RELATED OPTIONS:
 - P68E 6E** Fire Siren sound

KEYPAD FIRE ALARM

This option enables the Keypad Fire Alarm. Pressing  and then  activates the dialler and reports a Fire Alarm and triggers the siren. The "Fire Alarm" siren sound is different to the normal alarm siren sound.

PROGRAMMING SEQUENCE:

P64E 7E toggles the option ON and OFF

P64E 7E OFF: No Keypad Fire Alarm

P64E 7E ON: Keypad Fire Alarm enabled

P64E 8E

PROGRAM MODE LEVEL:

Installer, Remote by PC



FACTORY DEFAULT:

OFF: No Keypad Medical Alarm

NOTES:

- RELATED OPTIONS:

KEYPAD MEDICAL ALARM

This option enables the Keypad Medical Alarm. Pressing  and then  activates the dialler and reports a Medical Alarm.

PROGRAMMING SEQUENCE:

P64E 8E toggles the option ON and OFF

P64E 8E OFF: No Keypad Medical Alarm

P64E 8E ON: Keypad Medical Alarm enabled

PROGRAMMING

OPTION No	DESCRIPTION	Zones							
		1	2	3	4	5	6	7	8
P65E	Supervised Radio zones								

ON = Factory default setting

P65E

PROGRAM MODE LEVEL:

Installer, Remote by PC

FACTORY DEFAULT:

all OFF: No Radio Supervision zones

NOTES:

- **0E** will turn all selections OFF
MEMORY E will turn all selections ON
- RELATED OPTIONS:
P66E 1E–6E Radio Supervision Alerts
P67E Radio Supervision Time
P01E–P08E Programming Radio Devices

SUPERVISED RADIO ZONES

This option assigns zones that will operate as Radio Supervised types.

Supervised signals failure is reported (as per the P66E output options) when no signal is received from a Radio Supervision Zone for the Supervision Time P67E.

Radio Supervision for any zone is not enabled unless a Radio PIR is assigned to the zone, (P01E–P08E).

PROGRAMMING SEQUENCE:

P65E [Zone No]E toggles the options ON and OFF

P65E [Zone No]E OFF: The zone is not a Supervised Radio zone

P65E [Zone No]E ON: The zone is a Supervised Radio zone

P66E 1E–6E

RADIO SUPERVISION ALERTS, SUPERVISION TIME SPEEDUP

See pages 32–33

P67E

PROGRAM MODE LEVEL:

Installer, Remote by PC

FACTORY DEFAULT:

24hrs

NOTES:

- A setting of less than 3 hours is not recommended.
- The Supervision timer is reset on exit from Installer Program Mode, on Arm or Disarm and on reception of the Supervision signal from the particular Radio PIR.
- The Supervision signal from each Supervised Radio PIR is individually timed.
- RELATED OPTIONS:
P65E Radio Supervision Zones
P66E 1E–6E Radio Supervision Alerts
P66E 7E–8E Supervision Time Speed-up

See Page 56 for
Radio Device programming

SUPERVISION TIME

The SUPERVISION TIME is the time allowed between radio transmissions received by the D8 from any Supervised Ness Radio PIR (100–663).

The SUPERVISION TIME setting is from 01 to 24 hours.

PROGRAMMING SEQUENCE:

P67E existing time is displayed **[ENTER NEW TIME] E** new time is displayed

EXAMPLE: To program SUPERVISION TIME to be 4 hours:

P67E 04E

RADIO SUPERVISION

The purpose of Radio Supervision is to verify the correct operation of Ness Radio PIRs. The Supervision signal from the Radio PIR tells the panel that the device has not been removed from radio range and is in working order.

Non-SUPERVISION Radio PIRs can also be programmed and used with the D8 SUPERVISION TIMERS.

A non-SUPERVISION enabled Radio PIR will transmit signals to the D8 only when it has detected an event. Obviously, there is no guaranteed signal period.

In either case, when the allowed time limit is exceeded then a WARNING is first given (if programmed by P66E 3E), and then after 1 minute, the programmed RADIO SUPERVISION ALERTS are generated by the D8.

NOTE: Manually Excluding a Supervised Zone will also disable Radio Supervision for that zone.

PROGRAMMING

Supervision RESET output
 Supervision STROBE output
 Supervision SONALERT output
 Supervision SIREN output
 Supervision AUX1 output
 Supervision AUX2 output
 Supervision speedup x6
 Supervision speedup x10

OPTION No	DESCRIPTION	1E	2E	3E	4E	5E	6E	7E	8E
P66E	Radio Supervision Alerts								

ON = Factory default setting.

P66E 1E

PROGRAM MODE LEVEL:

Installer, Remote by PC

FACTORY DEFAULT:

OFF: Supervision Reset output disabled

NOTES:

- RELATED OPTIONS:
P65E Supervised Radio Zones

RADIO SUPERVISION ALERTS – RESET OUTPUT

Setting this option turns the Reset output ON when a SUPERVISED RADIO alert occurs. The Reset output will remain ON for the duration of the ALARM TIME (Set by Option P29E).

PROGRAMMING SEQUENCE:

P66E 1E toggles the option ON and OFF

P66E 1E OFF: Supervision Reset output disabled

P66E 1E ON: Supervision Reset output enabled

P66E 2E

PROGRAM MODE LEVEL:

Installer, Remote by PC

FACTORY DEFAULT:

OFF: Supervision Strobe output disabled

NOTES:

- RELATED OPTIONS:
P65E Supervised Radio Zones

RADIO SUPERVISION ALERTS – STROBE OUTPUT

Setting this option turns the Strobe output ON when a SUPERVISED RADIO alert occurs. The Strobe output will remain ON until the panel is disarmed.

PROGRAMMING SEQUENCE:

P66E 2E toggles the option ON and OFF

P66E 2E OFF: Supervision Strobe output disabled

P66E 2E ON: Supervision Strobe output enabled

P66E 3E

PROGRAM MODE LEVEL:

Installer, Remote by PC

FACTORY DEFAULT:

OFF: Supervision Keypad Sonalert disabled

NOTES:

- When this option is turned ON, it delays the operation of all other selected Supervision outputs by one minute.
- RELATED OPTIONS:
P65E Supervised Radio Zones

RADIO SUPERVISION ALERTS – KEYPAD SONALERT & DELAY ALL SUPERVISION OUTPUTS

Setting this option turns the Keypad Sonalert ON when a SUPERVISED RADIO alert occurs. The Keypad Sonalert remains ON until any keypad key is pressed.

Also, turning this option ON makes all Supervision outputs delayed by one minute.

PROGRAMMING SEQUENCE:

P66E 3E toggles the option ON and OFF

P66E 3E OFF: Supervision Keypad Sonalert disabled
AND all Supervision outputs trigger instantly

P66E 3E ON: Supervision Keypad Sonalert enabled
AND all Supervision outputs are delayed by 1 minute

PROGRAMMING

P66E 4E

PROGRAM MODE LEVEL:

Installer, Remote by PC

FACTORY DEFAULT:

OFF: Supervision Siren output disabled

NOTES:

- RELATED OPTIONS:
P65E Supervised Radio Zones

P66E 5E

PROGRAM MODE LEVEL:

Installer, Remote by PC

FACTORY DEFAULT:

OFF: Supervision AUX1 output disabled

NOTES:

- AUX1 output is Pin1 on the J3 header on the main board
- RELATED OPTIONS: P65E

P66E 6E

PROGRAM MODE LEVEL:

Installer, Remote by PC

FACTORY DEFAULT:

OFF: Supervision AUX2 output disabled

NOTES:

- AUX2 output is Pin2 on the J3 header on the main board
- RELATED OPTIONS: P65E

P66E 7E

PROGRAM MODE LEVEL:

Installer, Remote by PC

FACTORY DEFAULT:

OFF: Supervision Time normal

NOTES:

- RELATED OPTIONS:
P67E Supervision Time
P66E 8E Supervision Time speedup x10

P66E 8E

PROGRAM MODE LEVEL:

Installer, Remote by PC

FACTORY DEFAULT:

OFF: Supervision Time normal

NOTES:

- RELATED OPTIONS:
P67E Supervision Time
P66E 7E Supervision Time speedup x6
- P66E 7E & 8E are normally only used for Supervision testing purposes

RADIO SUPERVISION ALERTS – SIREN OUTPUT

Setting this option turns the Siren output ON when a SUPERVISED RADIO alert occurs. The Siren output will remain ON for the duration of the ALARM TIME (Set by Option P29E).

PROGRAMMING SEQUENCE:

P66E 4E toggles the option ON and OFF

P66E 4E OFF: Supervision Siren output disabled

P66E 4E ON: Supervision Siren output enabled

RADIO SUPERVISION ALERTS – AUX1 OUTPUT

Setting this option turns the AUX1 output ON when a SUPERVISED RADIO alert occurs.

PROGRAMMING SEQUENCE:

P66E 5E toggles the option ON and OFF

P66E 5E OFF: Supervision AUX1 output disabled

P66E 5E ON: Supervision AUX1 output enabled

RADIO SUPERVISION ALERTS – AUX2 OUTPUT

Setting this option turns the AUX2 output ON when a SUPERVISED RADIO alert occurs.

PROGRAMMING SEQUENCE:

P66E 6E toggles the option ON and OFF

P66E 6E OFF: Supervision AUX2 output disabled

P66E 6E ON: Supervision AUX2 output enabled

SUPERVISION TIME SPEEDUP X6

Setting this option speeds up the Supervision Time by 6. For instance if P67E is set to 1 hour (60 minutes), then this option will reduce it to 10 minutes. (i.e., 60 divided by 6).

PROGRAMMING SEQUENCE:

P66E 7E toggles the option ON and OFF

P66E 7E OFF: Supervision Time normal as set by P67E

P66E 7E ON: Supervision Time speedup x6

SUPERVISION TIME SPEEDUP X10

Setting this option speeds up the Supervision Time by 10. For instance if P67E is set to 1 hour (60 minutes), then this option will reduce it to 6 minutes. (i.e., 60 divided by 10).

PROGRAMMING SEQUENCE:

P66E 8E toggles the option ON and OFF

P66E 8E OFF: Supervision Time normal as set by P67E

P66E 8E ON: Supervision Time speedup x10

NOTE: If both P66E 7E and 8E are both ON then the Supervision time is sped up by 60. For instance if P67E is set to 1 hour (60 minutes), then this option will reduce it to 1 minute. (i.e., 60 divided by 60).

PROGRAMMING

3K3 zone resistors
 Radio Key Panic toggles AUX1
 Radio Key Panic pulses AUX1
 Radio Key Arming unsealed warning
 24hr zone fire siren sound
 4th button Radio Key for AUX1
 Quiet chirps on Arm/Disarm

OPTION No	DESCRIPTION	1E	2E	3E	4E	5E	6E	7E	8E
P68E	Miscellaneous options								

ON = Factory default setting.

P67E

SUPERVISION TIME, page 31

P68E 2E

PROGRAM MODE LEVEL:

Installer, Remote by PC

FACTORY DEFAULT:

OFF: No 3K3 zone resistors

NOTES:

- The 3K3 zone resistor option is useful when installing the panel in a site pre-wired with 3K3 resistors
- If Zone 8 is converted to a keyswitch input then a 2K2 monitoring resistor is always used

3K3 ZONE RESISTORS

Setting this option ON changes the Zone 1 to Zone 8 (and External Tamper) monitoring resistor from 2K2 to 3K3.

PROGRAMMING SEQUENCE:

P68E 2E toggles the option ON and OFF

P68E 2E OFF: 3K3 zone resistors disabled

P68E 2E ON: 3K3 zone resistors enabled

P68E 3E

PROGRAM MODE LEVEL:

Installer, Remote by PC

FACTORY DEFAULT:

OFF: Radio Key Panic to AUX1 disabled

NOTES:

- This option is useful for triggering external devices using Radio Key's Panic button. E.g., lighting, garage doors
- When this option is selected ON, the Radio Key Panic function is disabled.

RADIO KEY PANIC TOGGLES AUX1

Setting this option ON changes the action of the Radio Key Panic button so that the AUX1 output is toggled ON and OFF. (Each press on Panic toggles the state of AUX1 between ON and OFF).

If a 4 Button Key is used then this option can be used with the 4th key instead of the Panic key (using P68E 7E). This then allows the Panic key to still activate Panic reports.

PROGRAMMING SEQUENCE:

P68E 3E toggles the option ON and OFF

P68E 3E OFF: Radio Key Panic triggers control panel Panic

P68E 3E ON: Radio Key Panic toggles AUX1

P68E 4E

PROGRAM MODE LEVEL:

Installer, Remote by PC

FACTORY DEFAULT:

OFF: Radio Key Panic to AUX1 disabled

NOTES:

- When this option is selected ON, the Radio Key Panic function is disabled.
- If P68E 3E and 4E are both selected ON, then 4E has priority.

RADIO KEY PANIC PULSES AUX1

Setting this option ON changes the action of the Radio Key Panic button so that the AUX1 output is pulsed ON for 2 seconds. (That is; momentary ON for 2sec).

If a 4 Button Key is used then this option can be used with the 4th key instead of the Panic key (using P68E 7E). This then allows the Panic key to still activate Panic reports.

PROGRAMMING SEQUENCE:

P68E 4E toggles the option ON and OFF

P68E 4E OFF: Radio Key Panic triggers control panel Panic

P68E 4E ON: Radio Key Panic pulses AUX1

PROGRAMMING

P68E 5E

PROGRAM MODE LEVEL:

Installer, Remote by PC

FACTORY DEFAULT:

OFF: Radio Key siren warning disabled

NOTES:

-

P68E 6E

PROGRAM MODE LEVEL:

Installer, Remote by PC

FACTORY DEFAULT:

OFF: No 24hr Fire siren sound

NOTES:

- The keypad key sequence for FIRE (3 E) always outputs the FIRE siren sound

P68E 7E

PROGRAM MODE LEVEL:

Installer, Remote by PC

FACTORY DEFAULT:

OFF: 4th button for AUX1 disabled

NOTES:

- RELATED OPTIONS:
P68E 3E & 4E Radio Key Panic to AUX1

P68E 8E

PROGRAM MODE LEVEL:

Installer, Remote by PC

FACTORY DEFAULT:

OFF: Quiet Chirps disabled

NOTES:

- RELATED OPTIONS:
P64E 4E Arm/Disarm Chirps

RADIO KEY ARMING, UNSEALED ZONE WARNING

Setting this option ON allows a 2 second SIREN warning if there is an unsealed zone in an Area Armed by a Radio Key.

PROGRAMMING SEQUENCE:

P68E 5E toggles the option ON and OFF

P68E 5E OFF: Radio Key arming, siren warning disabled

P68E 5E ON: Radio Key arming, siren warning enabled

24HR ZONE FIRE SIREN SOUND

This option changes the siren sound when a 24hr zone is triggered.

PROGRAMMING SEQUENCE:

P68E 6E toggles the option ON and OFF

P68E 6E OFF: Fire siren sound disabled

P68E 6E ON: Fire siren sound enabled

4th BUTTON RADIO KEY FOR AUX1

Ness 4 Button Radio Key only – this option changes P68E 3E and 4E to work with the 4th Button of a 4 Button Radio Key instead of the PANIC button.

PROGRAMMING SEQUENCE:

P68E 7E toggles the option ON and OFF

P68E 7E OFF: 4th button Radio Key for AUX1 disabled

P68E 7E ON: 4th button Radio Key for AUX1 enabled

QUIET CHIRPS ON ARM/DISARM

This quietyens the siren chirps that are made whenever keyswitch or radio key Arming or Disarming is used.

(Arm/Disarm Chirps must be enabled at P64E 4E).

PROGRAMMING SEQUENCE:

P68E 8E toggles the option ON and OFF

P68E 8E OFF: Quiet Chirps disabled

P68E 8E ON: Quiet Chirps enabled

PROGRAMMING

ARM1 pulse output
 ARM2 pulse output
 Quiet Monitor siren
 6 beeps on Arming
 Radio Key Monitor Arming

OPTION No	DESCRIPTION	1E	2E	3E	4E	5E	6E	7E	8E
P69E	Miscellaneous options 2								

ON = Factory default setting.

P69E 1E

PROGRAM MODE LEVEL:
 Installer, Remote by PC

FACTORY DEFAULT:
 OFF: ARM1 output toggles

NOTES:

- This is useful as a Smoke Detector reset output with an optional external relay.
- RELATED OPTIONS:
P60E 8E Delay ARM1/ARM2 outputs

ARM1 PULSE OUTPUT

This option selects the ARM1 output to pulse on for 2 seconds whenever arming or disarming of Area1.

(The ARM1 output normally toggles when arming/disarming).

Note also that when Arming with the P60E 8E option selected that the pulse will occur at the end of Exit Time.

PROGRAMMING SEQUENCE:

P69E 1E toggles the option ON and OFF

P69E 1E OFF: ARM1 output toggles

P69E 1E ON: ARM1 output pulses

P69E 2E

PROGRAM MODE LEVEL:
 Installer, Remote by PC

FACTORY DEFAULT:
 OFF: ARM2 output toggles

NOTES:

- This is useful as a Smoke Detector reset output with an optional external relay.
- RELATED OPTIONS:
P60E 8E Delay ARM1/ARM2 outputs

ARM2 PULSE OUTPUT

This option selects the ARM2 output to pulse on for 2 seconds whenever Arming or Disarming of Area2.

(The ARM2 output normally toggles when arming/disarming).

Note also that when Arming with the P60E 8E option selected that the pulse will occur at the end of Exit Time.

PROGRAMMING SEQUENCE:

P69E 2E toggles the option ON and OFF

P69E 2E OFF: ARM2 output toggles

P69E 2E ON: ARM2 output pulses

P69E 3E

PROGRAM MODE LEVEL:
 Installer, Remote by PC

FACTORY DEFAULT:
 OFF: Normal siren sound in Monitor Mode

NOTES:

- This does not affect the RESET output

QUIET MONITOR SIREN

This option selects the 'Quiet Siren' sound in Monitor Mode.

The Quiet Siren sound is a continuous "beep beep beep" sound rather than the normal siren sound.

PROGRAMMING SEQUENCE:

P69E 3E toggles the option ON and OFF

P69E 3E OFF: Normal siren sound in Monitor Mode

P69E 3E ON: Quiet Siren sound in Monitor Mode

PROGRAMMING

P69E 4E

PROGRAM MODE LEVEL:

Installer, Remote by PC

FACTORY DEFAULT:

OFF: Keypad gives 3 beeps on Arming

NOTES:

- The keypad beeps on Arm/Disarm when Arming/Disarming by keypad, keyswitch or by Radio Key

6 BEEPS ON ARMING

Normally the keypad/s onboard SONALERT gives 3 beeps when the D8 is Armed. Turning this option ON will give 6 keypad beeps when Arming.

PROGRAMMING SEQUENCE:

P69E 4E *toggles the option ON and OFF*

P69E 4E OFF: Keypad gives 3 beeps on Arming

P69E 4E ON: Keypad gives 6 beeps on Arming

P69E 5E

PROGRAM MODE LEVEL:

Installer, Remote by PC

FACTORY DEFAULT:

OFF: Radio Keys cannot Arm Monitor Mode

NOTES:

-

RADIO KEY MONITOR ARMING

Setting this option on allows a double press of a Radio Key OFF button to ARM the D8 in MONITOR mode.

(Requires two presses of the Radio Key OFF button within 4 seconds).

PROGRAMMING SEQUENCE:

P69E 5E *toggles the option ON and OFF*

P69E 5E OFF: Radio Key Monitor Mode Arming disabled

P69E 5E ON: Radio Key Monitor Mode Arming enabled

PROGRAMMING

OPTION No	DESCRIPTION	FACTORY DEFAULT
P70E	Telephone Number 1 - Primary	none
P71E	Telephone Number 2 - Secondary	none
P80E	Telephone Number 3 - Test Calls	none
P81E	Telephone Number 4 - Callback for Up/download	none
P00E	Follow Me Telephone Number - For Audible Dialling	none

OPTION No	DESCRIPTION	FACTORY DEFAULT
P72E	Account Number 1	0000
P73E	Account Number 2	0000

P70E, P71E

PROGRAM MODE LEVEL:
Installer, Remote by PC

FACTORY DEFAULT:
No telephone numbers

NOTES:

- If telephone number 2 is disabled, all calls are made on telephone number 1 and the setting of P87E 1E has no effect.
- If telephone number 3 is disabled, all test calls are made on telephone number 1&2
- Any keypress will stop the telephone number display sequence
- RELATED OPTIONS:
P87E 1E Alternate Primary/Secondary telephone numbers
P86E 1E Disable dialler (still allows remote up/download if programmed)

TELEPHONE NUMBERS 1 & 2

The D8 can dial up to 2 phone numbers when an event is to be transmitted to a remote location. Telephone numbers may be up to 15 digits long.

PROGRAMMING SEQUENCE:

P70E existing telephone number is displayed
[ENTER NEW TELEPHONE No] E new telephone number is displayed

EXAMPLE: To program Telephone No.1 to be 03 1234 1234:
P70E 0312341234E

SPECIAL FUNCTIONS FOR ALL TELEPHONE NUMBERS

TO CLEAR A TELEPHONE NUMBER

To clear a telephone number, enter the MEMORY key in place of the telephone number. Example, to clear a Telephone Number 1 press: P70E MEMORY E

SPECIAL CHARACTERS (Applies to all telephone Numbers)

Pauses, * (star) or # (hash) (VF digits) can be included in the dialling sequence by using the keys in the table below.

<u>SPECIAL CHARACTER</u>	<u>KEY ENTRY</u>	<u>DISPLAYED ON LCD DISPLAY</u>
PAUSE (1.6sec)	ARM Key	12
* (Star)	MONITOR Key	10
# (Hash)	EXCLUDE Key	11

P72E, P73E

PROGRAM MODE LEVEL:
Installer, Remote by PC

FACTORY DEFAULT:
P72E Account No.1: 0000
P73E Account No.2: 0000

NOTES:

- RELATED OPTIONS:
P79E Account No.2 zones

ACCOUNT NUMBER 1 & 2

Account numbers for identifying the panel to the Central Station. Area 1 Open/Close reports will report on Account No.1 and Area 2 Open/Close reports will report on Account No.2.

Zone Alarms can be assigned to report on either Account Number as set by Option P79E.

All miscellaneous events (eg. Tamper, Mains Fail) will report on Account No. 1.

PROGRAMMING SEQUENCE:

P72E (or P73E) existing account number is displayed
[ENTER NEW ACCOUNT No] E new account number is displayed

EXAMPLE: To program Account No.1 to be 1239:
P72E1239E

PROGRAMMING

P80E

PROGRAM MODE LEVEL:

Installer, Remote by PC

FACTORY DEFAULT:

No telephone numbers

NOTES:

- RELATED OPTIONS:
 - P89E 1E** Enable test calls
 - P83E** Test call interval
 - P84E** Test call start delay

P81E

PROGRAM MODE LEVEL:

Installer, Remote by PC

FACTORY DEFAULT:

No telephone numbers

NOTES:

- RELATED OPTIONS:
 - P90E 8E** Enable Callback

P00E

PROGRAM MODE LEVEL:

User, Installer, Remote by PC

FACTORY DEFAULT:

No telephone numbers

NOTES:

- If the Follow Me telephone number is disabled, all audible format calls are made on telephone numbers 1 & 2.
- RELATED OPTIONS:
 - P86E 3E** Audible DTMF format
 - P86E 4E** Audible Pulse format
 - P86E 5E** Contact ID + Audible DTMF
 - P86E 6E** Contact ID + Audible Pulse

TELEPHONE NUMBER 3 – TEST CALLS

Phone Number 3 is used to send Test Calls. If it is not programmed then Test Calls are sent using Telephone No 1 & 2.

PROGRAMMING SEQUENCE:

P80E existing telephone number is displayed

[ENTER NEW TELEPHONE No] E new telephone number is displayed

EXAMPLE: To program Telephone No.3 to be 03 2468 1234:

P70E0324681234E

TELEPHONE NUMBER 4 – CALLBACK

Phone Number 4 is used for upload/download.

Prevents unauthorised up/download – the panel will dial the callback telephone number to commence an up/download session.

Up/download without callback is allowed by turning off option P90E 8E.

PROGRAMMING SEQUENCE:

P81E existing telephone number is displayed

[ENTER NEW TELEPHONE No] E new Telephone No.4 is displayed

EXAMPLE: To program Telephone No.4 to be 02 8825 1234:

P70E0288251234E

FOLLOW ME TELEPHONE NUMBER

The Follow Me telephone number is only used in Audible Dialling mode. (P86E 3E, 4E, 5E or 6E are on).

The Follow Me telephone number can be programmed in User Program Mode. If the Follow Me number is programmed, then the primary & secondary numbers are ignored.

PROGRAMMING SEQUENCE:

P00E existing telephone number is displayed

[ENTER NEW TELEPHONE No] E new telephone number is displayed

EXAMPLE: To program Telephone No.4 to be 02 8825 1234:

P70E0288251234E

PROGRAMMING

OPTION No	DESCRIPTION	Zones							
		1	2	3	4	5	6	7	8
P74E	Report zone alarms	ON	ON	ON	ON	ON	ON	ON	ON
P76E	Report zone restorals	ON	ON	ON	ON	ON	ON	ON	ON
P78E	Multiple zone alarms								
P79E	Account No.2 zones								

ON = Factory default setting

P74E

PROGRAM MODE LEVEL:
Installer, Remote by PC

FACTORY DEFAULT:
All zones report Alarms

NOTES:

- **OE** will turn all selections OFF
MEMORY E will turn all selections ON

P76E

PROGRAM MODE LEVEL:
Installer, Remote by PC

FACTORY DEFAULT:
All zones report Restorals

NOTES:

- **OE** will turn all selections OFF
MEMORY E will turn all selections ON
- RELATED OPTIONS:
P82E 1E Send Restoral immediately
P82E 2E Send Restoral after siren time
P82E 3E Send Restoral on Disarm & seal
P82E 4E Send Restoral on Disarm always

P78E

PROGRAM MODE LEVEL:
Installer, Remote by PC

FACTORY DEFAULT:
No zones report Multiple Alarms

NOTES:

- Only zones that have previously sent an Alarm will send a Restoral
- **OE** will turn all selections OFF
MEMORY E will turn all selections ON
- RELATED OPTIONS:
P89E 4E Swinger shutdown

P79E

PROGRAM MODE LEVEL:
Installer, Remote by PC

FACTORY DEFAULT:
All zones report Restorals

NOTES:

REPORT ZONE ALARMS

This option selects which zone inputs will send Alarm reports to the Central Station.

PROGRAMMING SEQUENCE:

P74E [Zone No]E toggles the option ON and OFF

P74E 1E–8E OFF: Alarm reporting disabled for that zone

P74E 1E–8E ON: Alarm reporting enabled for that zone

REPORT ZONE RESTORALS

This option selects which zone inputs will send Restoral reports to the Central Station. Only zones that have previously sent an Alarm will send a Restoral.

PROGRAMMING SEQUENCE:

P76E [Zone No]E toggles the option ON and OFF

P76E 1E–8E OFF: Restoral reporting disabled for that zone

P76E 1E–8E ON: Restoral reporting enabled for that zone

REPORT MULTIPLE ZONE ALARMS

Zones selected for Multiple Zone Alarms will report each time the zone alarms and without a restore being sent. The number of reports is a maximum of 15. The number of alarms sent for each Multiple Zone Alarm can be reduced to 3 by using the swinger shutdown option P89E 4E.

Zones not selected report only once, until reset by an opening or a valid code.

PROGRAMMING SEQUENCE:

P78E [Zone No]E toggles the option ON and OFF

P78E 1E–8E OFF: Multiple Zone Alarms disabled for that zone

P78E 1E–8E ON: Multiple Zone Alarms enabled for that zone

ACCOUNT NO.2 ZONES

Zones selected to be Account No.2 zones will report their Alarms, Restorals and Excludes on Client code 2.

PROGRAMMING SEQUENCE:

P79E [Zone No]E toggles the option ON and OFF

P79E 1E–8E OFF: Multiple Zone Alarms disabled for that zone

P79E 1E–8E ON: Multiple Zone Alarms enabled for that zone

PROGRAMMING

OPTION No	DESCRIPTION	1E Duress	2E Medical	3E K/P & K/S Panic	4E Fire	5E Panel Tamper	6E External Tamper	7E Keypad Tamper	8E Exit Install mode
P75E	Report Misc. Alarms 1~8			ON		ON	ON	ON	
P77E	Report Misc. Restorals 1~8	ON	ON	ON	ON	ON	ON	ON	ON

ON = Factory default setting.

OPTION No	DESCRIPTION	1E Radio Tamper	2E Radio Panic	3E Radio Battery	4E Supervision Fail	5E Panel Battery	6E Mains Fail	7E	8E
P92E	Report Misc. Alarms 9~14	ON	ON			ON	ON		
P93E	Report Misc. Restorals 9~14	ON	ON	ON	ON	ON	ON	ON	ON

P75E, P92E

REPORT MISCELLANEOUS ALARMS

PROGRAM MODE LEVEL:
Installer, Remote by PC

FACTORY DEFAULT:
see table

NOTES:

- **0E** will turn all selections OFF
MEMORY E will turn all selections ON

P77E, P93E

REPORT MISCELLANEOUS RESTORALS

PROGRAM MODE LEVEL:
Installer, Remote by PC

FACTORY DEFAULT:
see table

NOTES:

- Mains Fail and Low Battery Restorals are sent when the power has been restored
- **0E** will turn all selections OFF
MEMORY E will turn all selections ON

REPORT MISCELLANEOUS ALARMS REPORT MISCELLANEOUS RESTORALS

These options select which Miscellaneous alarms will trigger the dialler to send Alarm reports and Restoral reports to the Central Station.

Alarms (if enabled) are sent on activation. Restorals (if enabled) are sent on Opening. Mains Fail and Low Battery Restorals are sent when the power has been restored.

PROGRAMMING SEQUENCE:

PxxE 1E-8E

toggles the option ON and OFF

MISCELLANEOUS ALARMS:

ALARM P75E	1E	1. Duress
	2E	2. Medical
	3E	3. Keypad & K/Switch Panic
	4E	4. Fire
RESTORAL P77E	5E	5. Panel Tamper
	6E	6. External Tamper
	7E	7. Keypad Tamper
	8E	8. Exit Install Mode
ALARM P92E	1E	9. Radio Tamper
	2E	10. Radio Panic (by User)
	3E	11. Radio Low Battery (by Device)
	4E	12. Supervision Fail
RESTORAL P93E	5E	13. Panel Low Battery
	6E	14. Mains Fail

Restoral immediately
Restoral after siren time
Restoral on Disarm & seal
Restoral on Disarm always

OPTION No	DESCRIPTION	1E	2E	3E	4E	5E	6E	7E	8E
P82E	Zone Restoral reporting options				ON				

ON = Factory default setting.

P82E 1E-4E

PROGRAM MODE LEVEL:
Installer, Remote by PC

FACTORY DEFAULT:
4E, ON: Always send Restoral on Disarm

NOTES:

- **RELATED OPTIONS:**
P76E Report zone restorals

RESTORAL REPORTING OPTIONS

This option selects when the dialler sends zone Restoral reports. Only one of the following options may be selected.

Restoral reporting options also apply to 24hr zones.

PROGRAMMING SEQUENCE:

P82E 1E-4E *toggles the option ON and OFF*

- P82E 1E: Send Restoral immediately
- P82E 2E: Send Restoral after siren time
- P82E 3E: Send Restoral on Disarm & seal
- P82E 4E: Send Restoral on Disarm always

PROGRAMMING

OPTION No	DESCRIPTION	DEFAULT	NOTE
P83E	Test Call Interval	84	x2 = 168hrs (7 days)
P84E	Time Before Next Test Call	6	x2 = 12hrs

P83E

PROGRAM MODE LEVEL:
Installer, Remote by PC

FACTORY DEFAULT:
84 (=168hrs =7 days)

- NOTES:**
- Enter a value from 1 to 99
 - RELATED OPTIONS:
P89E 1E Enable Test Calls
P84E Time Before Next Test Call

TEST CALL INTERVAL

Test calls to the Central Station can be sent at intervals between 2 and 198 hours in 2 hour increments.

Programmable from 2 to 198 Hours. Enter a value between 1 and 99. (This is automatically multiplied by 2).

Test Calls must be enabled by option P89E 1E.

PROGRAMMING SEQUENCE:

P83E existing Test Call Interval time is displayed
[ENTER NEW TIME] E new Test Call Interval time is displayed

EXAMPLE: To program daily test calls:
P83E12E

P84E

PROGRAM MODE LEVEL:
Installer, Remote by PC

FACTORY DEFAULT:
6 (=12hrs)

- NOTES:**
- Enter a value from 1 to 99
 - If Test Calls are to start immediately, then the value is set to 0.
 - The Time Before Next Test Call is constantly updated. When viewed, the current value will be displayed (not the initially entered value).
 - RELATED OPTIONS:
P89E 1E Enable Test Calls
P83E Test Call interval

TIME BEFORE NEXT TEST CALL

This option sets the time before the next Test Call and is used to set the preferred time for Test Calls. Programmable from 2 to 198 Hours. Enter a value between 1 and 99. (This is automatically multiplied by 2).

EXAMPLES:

A/ New Installation: Set the time before the first test call.
E.g., If you are programming the panel at 5pm and you want test calls to be sent at 1am. Enter P84E 4E (4 x 2 =8hrs. Therefore 5pm + 8hrs =1am).

B/ Existing Installation: To reset the time that test calls are sent.
E.g., Our example panel is sending test calls at 1am and you want to change it to 2am. If you are programming the panel at 6pm, enter P84E 4E (4 x 2 =8hrs. Therefore 6pm + 8hrs =2am).

PROGRAMMING SEQUENCE:

P84E existing Time Before Next Test Call is displayed **(See note 3)**
[ENTER NEW TIME] E new Time Before Next Test Call is displayed

Auto dialling method
PULSE Dialling always
DTMF dialling always

OPTION No	DESCRIPTION	1E	2E	3E	4E	5E	6E	7E	8E
P85E	Dialling Method	ON							

ON = Factory default setting.

P85E 1E-3E

PROGRAM MODE LEVEL:
Installer, Remote by PC

FACTORY DEFAULT:
1E, ON: Auto Dialling Method

- NOTES:**
- Only one option is allowed to be ON

DIALLING METHOD

The dial format is determined by the detected Dial Tone. By default, if no dial tone is detected after looping the line then the dialler will attempt to dial regardless alternating between PULSE (Decadic) first and then DTMF dialling.

PROGRAMMING SEQUENCE:

P85E 1E-3E turns the option ON
P85E 1E: Auto Dialling (PULSE or DTMF)
P85E 2E: Pulse Dialling always
P85E 3E: DTMF Dialling always

PROGRAMMING

Disable dialler
 Contact ID format
 Audible DTMF-format
 Audible PULSE format
 Contact ID + Audible DTMF
 Contact ID + Audible PULSE

OPTION No	DESCRIPTION	1E	2E	3E	4E	5E	6E	7E	8E
P86E	Reporting Formats		ON						

ON = Factory default setting.

P86E 1E

PROGRAM MODE LEVEL:
 Installer, Remote by PC

FACTORY DEFAULT:
 Off: dialler enabled

- NOTES:**
- This option is useful for temporary disabling of the dialler without affecting other dialler options.
 - Only one option in the range P86E 1E—6E is allowed to be ON

P86E 2E

PROGRAM MODE LEVEL:
 Installer, Remote by PC

FACTORY DEFAULT:
 ON: Contact ID format enabled

- NOTES:**
- Only one option in the range P86E 1E—6E is allowed to be ON

P86E 3E

PROGRAM MODE LEVEL:
 Installer, Remote by PC

FACTORY DEFAULT:
 OFF

- NOTES:**
- Only one option in the range P86E 1E—6E is allowed to be ON

P86E 4E

PROGRAM MODE LEVEL:
 Installer, Remote by PC

FACTORY DEFAULT:
 OFF

- NOTES:**
- Only one option in the range P86E 1E—6E is allowed to be ON
 - This is the best option to select for Audible Monitoring.

DISABLE DIALLER

This option disables the dialler even if telephone numbers and other dialler options are programmed.

Up download or remote telephone access remain enabled.

PROGRAMMING SEQUENCE:

- P86E 1E** turns the option ON
- P86E 1E ON: Dialler disabled

CONTACT ID FORMAT

This option enables the reporting of alarms to a Central station via telephone numbers 1 & 2 using Contact ID format.

PROGRAMMING SEQUENCE:

- P86E 2E** turns the option ON
- P86E 2E ON: Contact ID format enabled

AUDIBLE DTMF FORMAT

For Audible Monitoring to any telephone or mobile phone. The last digit of the Account number and the zone alarm are sent in Audible DTMF format.

The message is repeated for 45 seconds or until kissed-off by the receiving telephone.

PROGRAMMING SEQUENCE:

- P86E 3E** turns the option ON
- P86E 3E ON: Audible DTMF format enabled

AUDIBLE PULSE FORMAT

For Audible Monitoring to any telephone or mobile phone. The last digit of the Account number and the zone alarm are sent in Audible PULSE format.

The message is repeated for 45 seconds or until kissed-off by the receiving telephone.

PROGRAMMING SEQUENCE:

- P86E 4E** turns the option ON
- P86E 4E ON: Audible PULSE format enabled

PROGRAMMING

P86E 5E

PROGRAM MODE LEVEL:

Installer, Remote by PC

FACTORY DEFAULT:

OFF

NOTES:

- Only one option in the range
P86E 1E—6E is allowed to be ON

P86E 6E

PROGRAM MODE LEVEL:

Installer, Remote by PC

FACTORY DEFAULT:

OFF

NOTES:

- Only one option in the range
P86E 1E—6E is allowed to be ON

The D8 reports alarms to the Central Station using Contact ID dialler format.

The message format is fixed as shown in the Contact ID Codes Table.

The message takes the form of:

- AAAA** – Account Number (P72E)
- Q** – Event qualifier
- XYZ** – Alarm type
- GG** – Group or Area designation
- CCC** – Alarm number
- Suffix** – Event checksum

CONTACT ID + AUDIBLE DTMF FORMAT

For simultaneous Central Station and Audible Monitoring.

The alarm message will be sent to the Central Station on the Primary telephone number and then in audible DTMF format to the Follow Me telephone number.

PROGRAMMING SEQUENCE:

P86E 5E turns the option ON

P86E 5E ON: Contact ID + Audible DTMF format enabled

CONTACT ID + AUDIBLE PULSE FORMAT

For simultaneous Central Station and Audible Monitoring.

The alarm message will be sent to the Central Station on the Primary telephone number and then in audible PULSE format to the Follow Me telephone number.

PROGRAMMING SEQUENCE:

P86E 6E turns the option ON

P86E 6E ON: Contact ID + Audible PULSE format enabled

CONTACT ID CODES TABLE

ALARM EVENT	ACCOUNT NUMBER	Q	XYZ	GG	CCC	SUFFIX
Zones 1~8 Alarm	AAAA	Q	130	GG	001-008	k
Duress	AAAA	Q	121	01	030	k
Keyswitch Panic	AAAA	Q	120	01	031	k
Keypad Panic	AAAA	Q	120	01	032	k
Radio Key Panic	AAAA	Q	120	01	by User	k
Medical Alarm	AAAA	Q	100	01	033	k
Fire	AAAA	Q	110	01	034	k
Exit Install mode	AAAA	Q	306	01	035	k
External Tamper	AAAA	Q	137	01	040	k
Internal Tamper	AAAA	Q	137	01	041	k
Keypad Tamper	AAAA	Q	137	01	042	k
Radio Sensor Tamper	AAAA	Q	383	01	by Device	k
Test Report	AAAA	Q	602	01	063	k
Mains Fail	AAAA	Q	301	01	050	k
Panel Battery Fail	AAAA	Q	309	01	051	k
Open	AAAA	Q	402	GG	by User	k
Close	AAAA	Q	402	GG	by User	k
Cancel	AAAA	Q	406	GG	by User	k
Zones 1~8 Manual Exclude	AAAA	Q	573	GG	001-008	k
Zones 1~8 Auto Exclude	AAAA	Q	380	GG	001-008	k

PROGRAMMING

Split dial Phone Nos.
 Check for dial tone
 4 dialling attempts

OPTION No	DESCRIPTION	1E	2E	3E	4E	5E	6E	7E	8E
P87E	Miscellaneous Dialling Options		ON		ON				

ON = Factory default setting.

P87E 1E

PROGRAM MODE LEVEL:

Installer, Remote by PC

FACTORY DEFAULT:

OFF: Alternate Dial

NOTES:

- RELATED OPTIONS:
 - P87E 4E Number of Dialling attempts

SPLIT DIAL PRIMARY/SECONDARY PHONE NUMBERS

This option selects the order in which Telephone numbers 1 & 2 are dialled.

PROGRAMMING SEQUENCE:

P87E 1E toggles the option ON and OFF

P77E 1E OFF: **Alternate Dial**

Dial Telephone No.1 on the first attempt. If no answer, dial Telephone No.2.
Continue alternating until successful.

P87E 1E ON: **Split Dial**

Dial Telephone No.1 for half of the call attempts. If unsuccessful, dial Telephone No.2 for the last half of call attempts.

P87E 2E

PROGRAM MODE LEVEL:

Installer, Remote by PC

FACTORY DEFAULT:

ON: Dial only with dial tone

NOTES:

CHECK FOR DIAL TONE

The dialler normally dials only if a dial tone is detected. The dialler can be forced to dial without a dial tone. Allows use on PABXs with non-standard dial tones.

PROGRAMMING SEQUENCE:

P87E 2E toggles the option ON and OFF

P77E 2E OFF: Dial without dial tone

P87E 2E ON: Dial only with dial tone

P87E 4E

PROGRAM MODE LEVEL:

Installer, Remote by PC

FACTORY DEFAULT:

ON: 4 dialling attempts

NOTES:

- Sets the total number of dialling attempts.
E.g. If 4 dialling attempts is selected, this means 2 attempts per telephone number.
- RELATED OPTIONS:
 - P87E 1E Alternate dialling

NUMBER OF DIALLING ATTEMPTS

Sets the number of dialling attempts when sending reports.

ON: allows a maximum of 4 dial attempts before a 5 minute sleep and 4 more retries if unsuccessful.

OFF: sets a maximum 10 dial attempts before a 5 minute sleep and 10 more retries if unsuccessful.

If all attempts fail the dialler waits for the next trigger event. The previously unsuccessful report will be included in the new message.

PROGRAMMING SEQUENCE:

P87E 4E toggles the option ON and OFF

P77E 4E OFF: Maximum 10 dialling attempts

P87E 4E ON: Maximum 4 dialling attempts

PROGRAMMING

AREA1 Open/Close report
 AREA2 Open/Close report
 Chirp Siren on kiss-off
 Flash Strobe on kiss-off
 Forced Opening report
 Delay Closing report
 Manual Exclude report
 Auto Exclude report

OPTION No	DESCRIPTION	1E	2E	3E	4E	5E	6E	7E	8E
P88E	Open/Close reporting options					ON		ON	ON

ON = Factory default setting.

P88E 1E

PROGRAM MODE LEVEL:

Installer, Remote by PC

FACTORY DEFAULT:

OFF: No AREA1 Open/Close reports

NOTES:

AREA1 OPEN/CLOSE REPORTS

Enables or disables sending of AREA1 Open/Close reports.

The User ID of the code used is included in the report. Keyswitch Arming and Shortcut Arming are identified as User 15.

PROGRAMMING SEQUENCE:

P88E 1E toggles the option ON and OFF

P88E 1E OFF: No AREA1 Open/Close reports

P88E 1E ON: AREA1 Open/Close reports enabled

P88E 2E

PROGRAM MODE LEVEL:

Installer, Remote by PC

FACTORY DEFAULT:

OFF: No AREA2 Open/Close

NOTES:

AREA2 OPEN/CLOSE REPORTS

Enables or disables sending of AREA2 Open/Close reports.

PROGRAMMING SEQUENCE:

P88E 2E toggles the option ON and OFF

P88E 2E OFF: No AREA2 Open/Close reports

P88E 2E ON: AREA2 Open/Close reports enabled

P88E 3E

PROGRAM MODE LEVEL:

Installer, Remote by PC

FACTORY DEFAULT:

OFF: No Siren Chirp on kiss-off

NOTES:

- RELATED OPTIONS:
P88E 4E Flash Strobe on kiss-off

SIREN CHIRP ON KISS-OFF

Selects a 2 Second Siren burst on a successful Closing report. This is used to give audible indication that the dialler has successfully sent the Arming report.

PROGRAMMING SEQUENCE:

P88E 3E toggles the option ON and OFF

P88E 3E OFF: No Siren Chirp on kiss-off

P88E 3E ON: Siren Chirp on kiss-off enabled

P88E 4E

PROGRAM MODE LEVEL:

Installer, Remote by PC

FACTORY DEFAULT:

OFF: No Strobe Flash on kiss-off

NOTES:

- RELATED OPTIONS:
P88E 3E Siren Chirp on kiss-off

STROBE FLASH ON KISS-OFF

Selects a 2 Second Strobe on a successful Closing report. This is used to give visual indication that the dialler has successfully sent the Arming report.

PROGRAMMING SEQUENCE:

P88E 4E toggles the option ON and OFF

P88E 4E OFF: No Strobe Flash on kiss-off

P88E 4E ON: Strobe Flash on kiss-off enabled

PROGRAMMING

P88E 5E

PROGRAM MODE LEVEL:

Installer, Remote by PC

FACTORY DEFAULT:

ON: Forced opening Reports enabled

NOTES:

- This option is used to indicate to the Central Station that an alarm has been reset by a valid user.

Usually used in cases where Open/Close reports are normally selected OFF.

P88E 6E

PROGRAM MODE LEVEL:

Installer, Remote by PC

FACTORY DEFAULT:

OFF: Closing Reports sent on Arming

NOTES:

- RELATED OPTIONS:
 - P88E 1E** AREA1 Open/Close reports
 - P88E 2E** AREA2 Open/Close reports

P88E 7E

PROGRAM MODE LEVEL:

Installer, Remote by PC

FACTORY DEFAULT:

ON: Manual Exclude Reports enabled

NOTES:

- RELATED OPTIONS:
 - P88E 8E** Auto Exclude Reports

P88E 8E

PROGRAM MODE LEVEL:

Installer, Remote by PC

FACTORY DEFAULT:

ON: Auto Exclude Reports enabled

NOTES:

- - P88E 7E** Manual Exclude Reports

FORCED OPENING REPORT

If Forced Opening Report is selected ON – when an alarm has been reset by a valid User Code (or Radio Key), the dialler will send an Opening report along with a restoral report for the zone or miscellaneous input which caused the alarm.

PROGRAMMING SEQUENCE:

P88E 5E toggles the option ON and OFF

P88E 5E OFF: No Forced opening Reports

P88E 5E ON: Forced opening Reports enabled

DELAY CLOSING REPORT

If selected ON, Closing reports (if enabled) are sent at the end of Exit Time. Normally, Closing reports are sent immediately on Arming.

PROGRAMMING SEQUENCE:

P88E 6E toggles the option ON and OFF

P88E 6E OFF: Closing Reports sent on Arming

P88E 6E ON: Closing Reports sent at end of Exit Time

MANUAL EXCLUDE REPORT

Enables Manual Exclude Reports for Zones 1~8. Exclude Reports for 24hr zones are sent on exiting EXCLUDE mode.

PROGRAMMING SEQUENCE:

P88E 7E toggles the option ON and OFF

P88E 7E OFF: No Manual Exclude Reports

P88E 7E ON: Manual Exclude Reports enabled

AUTO EXCLUDE REPORT

Enables Auto Exclude Reports for Zones 1~8. Zones not sealed on Arming will be reported as Auto Excluded..

PROGRAMMING SEQUENCE:

P88E 8E toggles the option ON and OFF

P88E 8E OFF: No Auto Exclude Reports

P88E 8E ON: Auto Exclude Reports enabled

PROGRAMMING

Enable Test Calls
Mains Report delay
Listen-in to dialler
Swinger shutdown
Line Fault Monitor
Line Fault to AUX2

OPTION No	DESCRIPTION	1E	2E	3E	4E	5E	6E	7E	8E
P89E	Miscellaneous Reporting options	ON	ON		ON				

ON = Factory default setting.

P89E 1E

PROGRAM MODE LEVEL:

Installer, Remote by PC

FACTORY DEFAULT:

ON: Test Calls enabled

NOTES:

- RELATED OPTIONS:
 - P83E Test Call Interval
 - P84E Time before next Test call

ENABLE TEST CALLS

This option enables the reporting of dialler test calls to the Central station.

PROGRAMMING SEQUENCE:

P89E 1E toggles the option ON and OFF

P89E 1E OFF: No Test Calls

P89E 1E ON: Test Calls enabled

P89E 2E

PROGRAM MODE LEVEL:

Installer, Remote by PC

FACTORY DEFAULT:

ON: Mains Fail report is delayed

NOTES:

MAINS REPORT DELAY

This option allows Mains Fail reports to be delayed by one hour if the mains power has been off continuously for that time. Normally, the Mains Fail report is sent immediately the power fails.

PROGRAMMING SEQUENCE:

P89E 2E toggles the option ON and OFF

P89E 2E OFF: Mains Fail reports immediately

P89E 2E ON: Mains Fail report is delayed by 1 hour

P89E 3E

PROGRAM MODE LEVEL:

Installer, Remote by PC

FACTORY DEFAULT:

OFF: No Listen-In

NOTES:

- For convenient and private Listen-In, temporarily connect a spare horn speaker to the Siren output.

LISTEN-IN TO DIALLER

This is a diagnostic feature for installers. Listen-In is turned on for a minimum of 4 minutes after exiting Program Mode.

During Listen-In, the dialler message and other telephone tones can be heard through the Siren output (at low volume) while the dialler is sending reports. The 4 minute period is restarted whenever any key on the keypad is pressed.

To turn Listen-In off, go back into Installer Program mode and toggle the option OFF.

PROGRAMMING SEQUENCE:

P89E 3E toggles the option ON and OFF

P89E 3E OFF: No Listen-In

P89E 3E ON: Listen-In enabled

PROGRAMMING

P89E 4E

PROGRAM MODE LEVEL:

Installer, Remote by PC

FACTORY DEFAULT:

ON: Swinger Shutdown enabled

NOTES:

- This prevents unnecessary multiple alarms reported to the Central station in cases, for example, where a door is 'swinging' in the wind.

P89E 5E

PROGRAM MODE LEVEL:

Installer, Remote by PC

FACTORY DEFAULT:

OFF: No Line Fault Monitor

NOTES:

- RELATED OPTIONS:
P89E 6E Line Fault to AUX2

P89E 6E

PROGRAM MODE LEVEL:

Installer, Remote by PC

FACTORY DEFAULT:

OFF: No Line Fault output

NOTES:

- RELATED OPTIONS:
P89E 5E Line Fault Monitor

SWINGER SHUTDOWN

Limits the number of calls made by a zone alarm when Multiple Zone Alarms are enabled for that zone.

If enabled, multiple reports are limited to three per zone.

PROGRAMMING SEQUENCE:

P89E 4E toggles the option ON and OFF

P89E 4E OFF: No Swinger Shutdown (unlimited multiple reports)

P89E 4E ON: Swinger Shutdown enabled (maximum 3 reports per zone)

LINE FAULT MONITOR

When this option is enabled, the telephone line is regularly tested. If the telephone line is not found, the Line light will commence flashing.

PROGRAMMING SEQUENCE:

P89E 5E toggles the option ON and OFF

P89E 5E OFF: No Line Fault Monitor

P89E 5E ON: Line Fault Monitor enabled

LINE FAULT TO AUX2

When this option is enabled, a telephone line fault condition will turn ON the AUX2 output. AUX2 will turn OFF when the telephone line is restored.

PROGRAMMING SEQUENCE:

P89E 6E toggles the option ON and OFF

P89E 6E OFF: No Line Fault output

P89E 6E ON: Line Fault to AUX2 enabled

PROGRAMMING

Upload/Download
Direct Connect
Remote Arming
Remote Disarming
Remote AUX control
Remote Status reporting
Remote Event reporting
Callback mode

OPTION No	DESCRIPTION	1E	2E	3E	4E	5E	6E	7E	8E
P90E	Upload/Download options								

ON = Factory default setting.

P90E 1E

PROGRAM MODE LEVEL:
Installer, Remote by PC

FACTORY DEFAULT:
OFF: No Remote Access

- NOTES:**
- RELATED OPTIONS:
P91E Required Rings

REMOTE ACCESS

When selected On, this option allows the panel to be remotely upload/downloaded by a remote computer or controlled by a remote telephone.

When the option is Off, the panel will not answer incoming telephone calls, preventing any type of remote access.

PROGRAMMING SEQUENCE:

- P90E 1E toggles the option ON and OFF
- P90E 1E OFF: No Remote Access
- P90E 1E ON: Remote Access enabled

P90E 2E

PROGRAM MODE LEVEL:
Installer, Remote by PC

FACTORY DEFAULT:
OFF: No Direct Connect

- NOTES:**
- Remote Access must also be enabled
 - RELATED OPTIONS:
P90E 1E Enable Upload/Download

DIRECT CONNECT

This allows a direct connection to be used between the D8 telephone output and an on site computer with modem. A special NESS adapter is required when using this connection.

Direct Connect simulates a telephone line ring and makes the D8 connect immediately to the telephone line.

PROGRAMMING SEQUENCE:

- P90E 2E toggles the option ON and OFF
- P90E 2E OFF: No Direct Connect
- P90E 2E ON: Direct Connect enabled

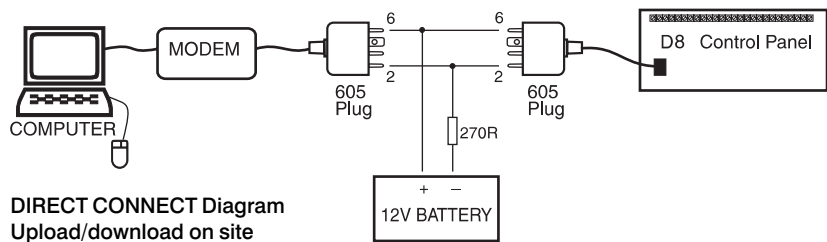

P90E 3E

PROGRAM MODE LEVEL:
Installer, Remote by PC

FACTORY DEFAULT:
OFF: No Remote Arming

- NOTES:**
- Remote Access must also be enabled
 - RELATED OPTIONS:
P90E 1E Enable Upload/Download
 - See page 59 for details on Remote Operation by telephone

REMOTE ARMING

Allows the remote Arming of the control panel using a standard DTMF telephone (or mobile phone) from anywhere in the world.

PROGRAMMING SEQUENCE:

- P90E 3E toggles the option ON and OFF
- P90E 3E OFF: No Remote Arming
- P90E 3E ON: Remote Arming enabled

PROGRAMMING

P90E 4E

PROGRAM MODE LEVEL:

Installer, Remote by PC

FACTORY DEFAULT:

OFF: No Remote Disarming

NOTES:

P90E 5E

PROGRAM MODE LEVEL:

Installer, Remote by PC

FACTORY DEFAULT:

OFF: No Remote AUX control

NOTES:

P90E 6E

PROGRAM MODE LEVEL:

Installer, Remote by PC

FACTORY DEFAULT:

OFF: No Remote Status Reporting

NOTES:

P90E 7E

PROGRAM MODE LEVEL:

Installer, Remote by PC

FACTORY DEFAULT:

OFF: No Remote Event Reporting

NOTES:

P90E 8E

PROGRAM MODE LEVEL:

Installer, Remote by PC

FACTORY DEFAULT:

OFF: No Callback

NOTES:**• RELATED OPTIONS:**

P90E 1E Enable Upload/Download

P81E Telephone Number 4, Callback

REMOTE DISARMING

Allows the remote Disarming of the control panel using a standard DTMF telephone (or mobile phone) from anywhere in the world.

PROGRAMMING SEQUENCE:

P90E 4E toggles the option ON and OFF

P90E 4E OFF: No Remote Disarming

P90E 4E ON: Remote Disarming enabled

REMOTE AUX CONTROL

Enables the remote turn ON/OFF of the AUX1 & AUX2 outputs using a standard DTMF telephone (or mobile phone) from anywhere in the world.

PROGRAMMING SEQUENCE:

P90E 5E toggles the option ON and OFF

P90E 5E OFF: No Remote AUX control

P90E 5E ON: Remote AUX control enabled

REMOTE STATUS REPORTING

Enables Remote Status Reporting

PROGRAMMING SEQUENCE:

P90E 6E toggles the option ON and OFF

P90E 6E OFF: No Remote Status Reporting

P90E 6E ON: Remote Status Reporting enabled

REMOTE EVENT REPORTING

Enables Remote Event Reporting

PROGRAMMING SEQUENCE:

P90E 7E toggles the option ON and OFF

P90E 7E OFF: No Remote Status Reporting

P90E 7E ON: Remote Status Reporting enabled

CALLBACK MODE

Enables two methods of connecting by computer for remote upload/download.

NO CALLBACK – Allows remote access by computer as long as the panel's Account Number (P72E) is known. The panel answers on the 2nd incoming call.

WITH CALLBACK – The panel will answer the 2nd call, verify the caller, hang up and then make the Callback using Telephone Number 4.

PROGRAMMING SEQUENCE:

P90E 8E toggles the option ON and OFF

P90E 8E OFF: No Callback

P90E 8E ON: Callback Mode enabled

PROGRAMMING

OPTION No	DESCRIPTION	DEFAULT	NOTE
P91E	Required Rings to answer	1	

P91E

PROGRAM MODE LEVEL:
Installer, Remote by PC

FACTORY DEFAULT:
1

NOTES:

- RELATED OPTIONS:
P90E 1E to 8E (All Remote Access options)

REQUIRED RINGS

Sets the number of double-rings before an incoming call is answered. This is used for Remote Access.

Programmable from 1 to 16 rings. Enter a value between 1 and 16.

See below for a detailed description.

PROGRAMMING SEQUENCE:

P91E existing Required Rings value is displayed
[ENTER NEW VALUE] E new Required Rings value is displayed

EXAMPLE: To make Required Rings = 3:

P91E3E

P66666666E

PROGRAM MODE LEVEL:
User Program Mode

FACTORY DEFAULT:
[not applicable]

SEND DIALLER TEST REPORT

Send a Dialler Test Report in **USER PROGRAM MODE**. Obviously, at least one telephone number must be programmed (P70E).

PROGRAMMING SEQUENCE:

P66666666E (eight 6's) Triggers dialler and sends test report to Central Station

P77777777E

PROGRAM MODE LEVEL:
Installer, User Program Mode

FACTORY DEFAULT:
[not applicable]

SIREN TEST

Turn the Siren, Reset and Strobe Outputs On. Pressing P E will stop the Siren Test (and also exits Program Mode).

PROGRAMMING SEQUENCE:

P77777777E (eight 7's) Triggers Siren, Reset, Strobe

P88888888E

PROGRAM MODE LEVEL:
Installer, User Program Mode

FACTORY DEFAULT:
[not applicable]

PANEL RESET

This function resets the microprocessor. The effect is the same as powering down and powering up again.

PROGRAMMING SEQUENCE:

P88888888E (eight 8's) Panel Reset

PROGRAMMING

These options allow selective restoring of various factory defaults. For example, you can default (clear) all the User Codes, without affecting any other programmed options.

OPTION No	DESCRIPTION	DEFAULT	NOTE
P95E	Clear Radio Devices	not applicable	
P96E	Clear Memory	not applicable	
P97E	Restore Factory Defaults	not applicable	
P98E	Clear User Codes	not applicable	
P99E	Program the Installer Code	000000	

P95E

PROGRAM MODE LEVEL:
Installer, Remote by PC

FACTORY DEFAULT:
[not applicable]

CLEAR RADIO DEVICES

This option clears all Radio Device Codes. (Except Radio Keys assigned to Radio Codes). Options P01E – P08E are defaulted (eg, Radio PIRs assigned to zones 1–8)

PROGRAMMING SEQUENCE:
P95E *Clears Radio Device Codes*

P96E

PROGRAM MODE LEVEL:
Installer, Remote by PC

FACTORY DEFAULT:
[not applicable]

CLEAR MEMORY

Enter P96E when in Installer Program mode to clear all events in the Alarm memory display.

PROGRAMMING SEQUENCE:
P96E *Clears Alarm Memory display*

P97E

PROGRAM MODE LEVEL:
Installer, Remote by PC

FACTORY DEFAULT:
[not applicable]

NOTES:

CLEAR PANEL OPTIONS

This option restores 'panel' program options to their factory default values. Defaults the options P00E, P26E to P93E, P99E. (This includes all options except User Codes, Radio Codes & Radio Devices).

PROGRAMMING SEQUENCE:
P97E *Restores Factory Defaults*

P98E

PROGRAM MODE LEVEL:
Installer, Remote by PC

FACTORY DEFAULT:
User Code 1: 123
All other codes: [blank]

NOTES:
• This option DOES NOT clear the Installer Code.

CLEAR USER CODES

This option clears all User codes and Radio Codes (Radio Keys) and restores factory default codes.

P09E–P10E are defaulted (Radio Codes assignment)
P11E – P25E are defaulted (User Codes 1–15)

PROGRAMMING SEQUENCE:
P98E *Clears User Codes*

P99E

PROGRAM MODE LEVEL:
Installer, Remote by PC

FACTORY DEFAULT:
000000

NOTES:

PROGRAM THE INSTALLER CODE

Programs the installer code. This code can be 3 to 6 digits long. Factory default installer code is 000000.

PROGRAMMING SEQUENCE:
P99E [Enter new code]E [Enter new code again]E
(Unlike User Codes, the installer code is not displayed when programming)

NESS RADIO

RADIO QUICK START

PROGRAMMING RADIO KEYS:

- ❶ Select which User Codes 2–8 will be Radio Codes (P09E–P10E)
- ❷ Select the User Code (P12E–P25E)
- ❸ Press 1E
The READY light will turn ON to indicate that the User Code is ready to accept the Radio Key
- ❹ Press the OFF button on the Radio Key to be programmed
If the Radio Key is accepted, the READY light will turn off and 3 beeps will sound

PROGRAMMING RADIO DEVICES (Radio PIRs etc):

- ❶ Select a zone to which the Radio PIR will be assigned (P01E–P08E)
- ❷ Press 1E
The READY light will turn ON to indicate that the zone is ready to accept the Radio Device.
- ❸ Trigger the Radio Device
If the Radio Device is accepted, the READY light will turn off, the ARMED light will turn on and 3 beeps will sound.

NOTES:

- The Ness Radio Interface is normally installed inside the control panel box.
- In cases where radio reception needs to be improved, the Radio Interface can be installed up to 50 metres away from the control panel. (Use 14/0.20 cable)
- If the Radio Interface must be installed inside a metal enclosure, the antenna wire should protrude outside the enclosure.
- For best performance, the antenna wire should not be kept straight and not coiled, shortened or extended.

NESS RADIO INTERFACE

The Ness Radio Interface (100–200) is the optional radio receiver required to enable all radio functions. Connection to the control panel is via a 4 wire loom and plug supplied with the Ness Radio Interface.

If the Ness Radio Interface is correctly installed, the D8 keypad will flash the RADIO light ON when any radio signal is detected (from both programmed and non-programmed radio devices).

NESS D8 CONTROL PANEL

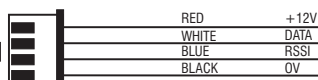

NESS RADIO INTERFACE

Part No. 100–200

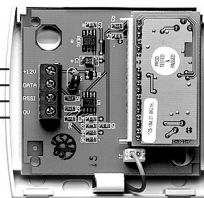

NOTES:

- Signal strength of Radio Keys can be tested in USER PROGRAM Mode or INSTALLER PROGRAM Mode.
- Signal strength of all other Radio Devices is tested in INSTALLER PROGRAM Mode.
- PRESS 3E to test the signal strength of the selected transmitter ONLY. (Other devices will be ignored).
- PRESS 4E to test the signal strength of ANY Ness transmitter (including unprogrammed devices).

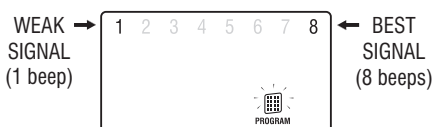

SIGNAL STRENGTH

The Signal Strength test can be used to test the radio signal from any Ness radio device. The strength of the radio signal received is displayed on the zone lights 1–8 and beeped by the keypad.

The higher the number displayed (and beeped) the stronger the signal received.

TEST SEQUENCE:

- ❶ Enter the option for the radio device to be tested
For Radio Keys: options P12E~P25E. For all other radio devices: options P01E~P08E
- ❷ Press 3E
- ❸ Trigger the radio device
 - One of zone lights 1–8 will turn ON to indicate the signal strength from the transmitter
 - The Signal Strength display remains on until another command is entered
 - To clear the display and re-test the transmitter, simply press 3E again (or 4E to test any other transmitter)

NESS RADIO

NESS RADIO DEVICES
Signal types transmitted



SIGNAL TYPE	RADIO KEY PENDANT 100-665	RADIO KEY 3 BUTTON 100-664	RADIO PIR 100-663	RADIO REED SWITCH 100-662	RADIO SMOKE DETECTOR 100-203
ALARM	ON button	ON button	yes	yes	yes
RESTORAL		OFF button	yes	yes	yes
LOW BATT	yes	yes	yes	yes	yes
TAMPER				yes	yes
SUPERVISION			yes	yes	yes

RADIO DEVICES – OPERATION

ALARM: Any Ness Radio Device can operate on any zone 1–8 as programmed by P01E–P08E. The hardwired zones 1–8 continue to operate in parallel.

Radio Keys can also operate on radio zones 1~8 for special purposes, but they should normally be used as Radio Codes.

KEYSWITCH INPUT: A Radio Device programmed to Zone 8 will still work as an alarm even if the Zone 8 input operation has been changed to Keyswitch operation. The P60E 2E and 3E options only affect the Zone 8 terminal inputs.

VIBRATION: Radio device zone signals IGNORE the P30E–P38E vibration sensor settings.

TAMPER REPORT: Radio Device Tamper operation depends on the Armed State of the control panel.

RADIO TAMPER: causes the keypad to continuously beep and also to flash the RADIO, TAMPER and the ZONE (identifying the detector) lights. Pressing any key on the keypad or sending a TAMPER RESTORE will clear this warning.

LOW BATTERY REPORT: A low battery gives 10 beeps and flashes the RADIO & the BATTERY light. The ZONE light identifying the radio device is also ON. The flashing lights stop when any key on the keypad is pressed or a detector code with no low battery is received. Low Battery generates HISTORY and DIALLER reports ONCE only (until the low battery is fixed and a restore report is received).

SUPERVISION: If a zone has the P65E option ON and a radio code has been programmed for that zone, then the supervision is active. This means that the radio detector does not need to have its SUPER enabled (via header link) for the SUPERVISED timeout to occur. (Useful as an inactivity alarm). A zone supervision failure always flashes the identifying ZONE light and the RADIO light.

RADIO SUPERVISION

The purpose of Radio Supervision is to verify the correct operation of Ness Radio PIRs. The Supervision signal from the Radio PIR tells the panel that the device has not been removed from radio range and is in working order.

Non-SUPERVISION Radio PIRs can also be programmed and used with the D8 SUPERVISION TIMERS.

A non-SUPERVISION enabled Radio PIR will transmit signals to the D8 only when it has detected an event. Obviously, there is no guaranteed signal period.

In either case, when the allowed time limit is exceeded then a WARNING is first given (if programmed by P66E 3E), and then after 1 minute, the programmed RADIO SUPERVISION ALERTS are generated by the D8.

NOTE: Manually Excluding a Supervised Zone will also disable Radio Supervision for that zone.

P01E ~ P08E

PROGRAM MODE LEVEL:

Installer, Remote by PC

FACTORY DEFAULT:

No Radio Devices programmed

NOTES:

- Radio Device programming is done by 'learning' the code by radio.
- Radio Devices codes can only be deleted by keypad.
- Some Ness Radio Devices send separate Alarm and Restore signals.
- Ness Radio Keys (100–664), can also be programmed to operate on radio zones, but they are normally used to operate Radio Codes as described on page 57.
- Late model Ness Radio PIRs (100–663) and Radio Reed Switches (100–662) send Supervision signals.

SUPERVISION RELATED OPTIONS:

P65E Supervised Radio Zones

P66E 1E–8E Radio Supervision Alerts

P67E Radio Supervision Time

P75E 12E Radio Supervision Fail Report

RELATED OPTIONS:

P09E–P10E Programming Radio Keys

RADIO DEVICES – OPTION TABLE

RADIO DEVICE PROGRAMMING

Each of the 8 zones of the D8 can be a radio zone. Once programmed, zones can accept both Radio Devices and normal zone inputs simultaneously.

The optional 100–200 Ness Radio Interface is required for Radio Devices to operate.

A Radio Device is any type of Ness transmitter including Radio PIR, Radio Reed Switches, Radio Smoke Detector.

PROGRAMMING RADIO DEVICES

Up to 8 Radio Devices can be assigned, (one per zone).

PROGRAMMING SEQUENCE – NO RESTORALS

Suitable for 100–663 **Radio PIR**, 100–665 **Radio Pendant**, 100–203 **Radio Smoke Detector**.

❶ Select a zone using **P01E – P08E**

The ARMED light will be ON if a Radio Device is already programmed to the zone. Press OE to delete.

❷ Press **1E**

The READY light will turn ON to indicate that the zone is ready to accept the Radio Device.

❸ Trigger the Radio Device

A. If the Radio Device is accepted, the READY light will turn off, the ARMED light will turn on and 3 beeps will sound.

B. If the READY light stays on and a warning beep sounds, the Radio Device is already assigned to another zone and must be cleared from that zone first.

EXAMPLE: To program a Radio PIR on zone 1:

P01E 1E Trigger the Radio PIR (or simply connect the battery)

PROGRAMMING SEQUENCE – WITH RESTORALS

Suitable for 100–662 **Radio Reed Switch**.

❶ Alarm the reed switch, ie., move the magnet away from the switch

Leave the reed switch in the alarm condition and wait until radio transmission has stopped.

❷ Select a zone using **P01E – P08E**

The ARMED light will be ON if a Radio Device is already programmed to the zone. Press OE to delete.

❸ Press **1E**

The READY light will turn ON to indicate that the zone is ready to accept the Radio Device.

❹ Restore the reed switch (place the magnet next to the switch)

A. If the Radio Device is accepted, the READY light will turn off, the ARMED light will turn on and 3 beeps will sound.

B. The MEMORY light will turn on to indicate that this device sends Restorals.

C. If the READY light stays on and a warning beep sounds, the Radio Device is already assigned to another zone and must be cleared from that zone first.

EXAMPLE: To program a Radio Reed Switch with Restorals on zone 2:

Alarm the reed switch **P02E 1E** Restore the reed switch

DELETING A RADIO DEVICE:

❶ Use **P01E** to **P08E** to select the zone

❷ Press **0E** to clear the device (3 beeps will sound)



TIP: To prevent conflicting radio signals when programming Radio Devices, disable each device once you have finished programming it. (Remove the battery or open the RADIO link).

Remember to enable all the devices when programming is completed.

NESS RADIO

P09E, P10E

PROGRAM MODE LEVEL:

Installer, Remote by PC

FACTORY DEFAULT:

No Radio Codes

NOTES:

- All User Codes can be Radio Codes except User Code 1 (Master Code) which is always a Keypad Code.
- Each User Code 2–15 can be either a Radio Code or a Keypad Code (not both).
- Radio Key programming is done by 'learning' the code by radio.
- Radio Codes can only be deleted by keypad in the case of a lost Radio Key.
- Radio Keys are allocated to User Codes, so that Open/Close reports are identified by user number when the control panel is base station monitored. (If Open/Close reports are enabled)
- Radio Codes cannot be made Arm Only
- **TIP:** When adding Radio Keys, start at e.g., User Code 9. This will keep codes 1 to 8 free for use as Keypad Codes.
- RELATED OPTIONS:
P01E–P08E Programming Radio Devices



100–664 Radio Key

ASSIGN RADIO CODES

User → * 2 3 4 5 6 7 8

Codes

2	3	4	5	6	7	8
---	---	---	---	---	---	---

PROGRAM

P09E User Codes 2-8

*Note: User Code 1 is always a keypad code.

User → 9 10 11 12 13 14 15

Codes

1	2	3	4	5	6	7
---	---	---	---	---	---	---

PROGRAM

P10E User Codes 9-15

RADIO CODES

Each of the 15 User Codes, except for the Master Code, can be programmed to be Radio Codes. This allows up to 14 Ness Radio Keys to be used for Arming and Disarming of the panel. The optional 100–200 Ness Radio Interface is required for Radio Keys to operate.

PROGRAMMING RADIO KEYS

Radio Keys can be assigned to take the place of User Codes 2 to 15. (User Code 1 is always a Keypad code.)

PROGRAMMING SEQUENCE:

- ➊ At option **P09E**, select which User Codes 2–8 will be Radio Codes
At option **P10E**, select which User Codes 9–15 will be Radio Codes
- ➋ Use **P12E** to **P25E** to select a User Code
The User Code selected must already be assigned as a Radio Code by options P09E or P10E
- ➌ Press **1E**
The READY light will turn ON to indicate that the User Code is ready to accept the Radio Key. If a code is already programmed the READY light will not turn on and a warning beep will sound. To clear the code, press 0E, then go back to step 3. (0E clears any Keypad Codes and Radio Keys).
- ➍ Press the **OFF** button on the Radio Key to be programmed
If the Radio Key is accepted, the READY light will turn off and 3 beeps will sound. If the READY light stays on and a warning beep sounds, the Radio Key is already assigned to another User Code and must be cleared from that User Code first.

EXAMPLE: To program a Radio Key at User Code 9:

P10E 1E P19E 1E then Press the OFF button on the Radio Key

DELETING A RADIO CODE:

- ➊ Use **P12E** to **P25E** to select the User Code
- ➋ Press **0E** to clear the code 3 beeps will sound

CODE TABLE

CODE	OPTION No	DESCRIPTION	FACTORY DEFAULT	ENABLE AS A RADIO CODE
User Code 1	P11E	Master Code	123	(Keypad Code only)
User Code 2	P12E			2E
User Code 3	P13E			3E
User Code 4	P14E			4E
User Code 5	P15E			5E
User Code 6	P16E			6E
User Code 7	P17E			7E
User Code 8	P18E			8E
User Code 9	P19E			1E
User Code 10	P20E			2E
User Code 11	P21E			3E
User Code 12	P22E			4E
User Code 13	P23E			5E
User Code 14	P24E			6E
User Code 15	P25E			7E
Installer Code	P99E	Installer Code	000000	

CENTRAL STATION MONITORING

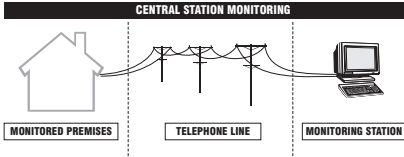

The D8 control panel has an on-board digital dialler which can send detailed alarm messages to a Central Monitoring Station.

The digital messages can include information about the zone/s which caused the alarm, tamper alarms, low battery or mains failure reports, and it can also (by user number) identify the users who Arm and Disarm the system.

Central Station Monitoring is highly recommended and is the most effective method of monitoring your D8 alarm system.

Installers are welcome to contact Ness for further information about monitoring.

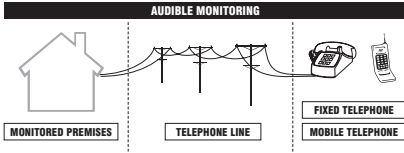

AUDIBLE MONITORING

While Central Station Monitoring is recommended, the D8 can also send audible alarm reports to any DTMF capable telephone. The types of alarms sent are listed in the Reporting Format Table.

The basic audible message takes the form of:

N [pause] **A** [pause] **B** [pause]

N = The first digit of the Account Number, P72E.

(**N** can be the digits 1–9. If P72E starts with 0, **N** is not sent).

A = First digit of the Alarm identifier (See Reporting Format Table).

B = Second digit of the Alarm identifier (See Reporting Format Table).

AUDIBLE MONITORING REPORTING FORMAT TABLE

DIGIT A	DIGIT B	ALARM
1	-	Zone 1
2	-	Zone 2
3	-	Zone 3
4	-	Zone 4
5	-	Zone 5
6	-	Zone 6
7	-	Zone 7
8	-	Zone 8
2	1	Duress
2	2	Keyswitch Tamper/Panic
2	3	Keypad Panic
2	4	Radio Panic
2	5	Medical alarm
2	6	Fire alarm
2	7	Exit from installer program mode
3	1	External Tamper
3	2	Internal Panel Tamper
3	3	Keypad Tamper
3	4	Radio Tamper
3	5	Mains Fail
3	6	Panel Battery Fail
4	1	RADIO Battery Fail
4	2	RADIO Supervision Fail

MESSAGE EXAMPLE (AUDIBLE PULSE FORMAT P86E 4E)

If the Account Number is 1234 and zone 5 alarm is reported:

beep [pause] **beep beep beep beep beep**
 1 Beep 5 Beeps = zone 5
 = 1st digit of the account number

REPORTING SEQUENCE

When triggered by an alarm event the D8 will call the Primary Telephone Number (or the Follow Me Telephone Number, if programmed) and at the end of the dialling of the last digit, it will wait for 5 seconds and then commence the audible message, the audible message will continue to repeat for 45 seconds or until it is kissed off by a DTMF tone.

If there is more than one alarm message to transmit then after it has received the Kiss-off/ Acknowledge tone it will commence transmission of the next message. The D8 should continue to do this until all alarm messages are transmitted and Kissed-off.

ACKNOWLEDGE TONE

The person receiving the call can then acknowledge the alarm by pressing the [#] key on their telephone. Press the [#] key for at least 2 seconds during pauses in the audible message.

If the alarm is not acknowledged, the keypad's LINE light will flash continuously until the panel is next Armed.

ALARM EVENTS SENT

The Reporting Format Table identifies the alarm events which can be programmed to be sent in Audible Format.

Open/Close reports, Restorals and Exclusions (Isolates) are NOT sent in Audible Format, even if selected ON.

OPERATING THE D8 BY TELEPHONE

AUDIBLE FEEDBACK

 3 BEEPS:

- The User Code is valid
- Successful Arming or Disarming
- An Auxiliary output has been turned ON.

 1 LONG BEEP:

- D8 is already Armed
- Invalid code. Try again.

 1 SHORT BEEP:

- An Auxiliary output has been turned OFF.

SUMMARY OF TELEPHONE COMMANDS

- 0** Prepare to receive commands
- 1 #** Arm Areas
- 2 #** Disarm Areas
- 3 #** Turn Aux 1 Output ON or OFF
- 4 #** Turn Aux 2 Output ON or OFF
- * #** Finished – hang up

The D8 will allow a user to call in to the panel, using a standard DTMF telephone, and remotely Arm or Disarm all areas and also turn on or off Aux 1 and Aux 2.

To maintain panel security, remote operations can only be activated after entering a valid user code.

To operate the D8 by telephone, you need a DTMF capable telephone, a valid User Code and you must know the Telephone number of the line to which the D8 is connected.

NOTES

- If the D8 does not receive commands for periods longer than 10 seconds it will assume that the call is finished and it will hang up.

- If an alarm occurs which requires the D8 to dial out while attempting remote control, the D8 will treat the alarm as a priority, give a constant tone as a warning and then hang up.

- When all remote control commands are finished press *** #** to force the D8 to hang up.

SEQUENCE OF OPERATION.

1. Phone the D8 telephone number and listen for the required number of rings (ring ring...ring ring) and then hang up.
2. Wait 10 seconds and then call the number again within 50 seconds.
3. The D8 will answer the second call immediately, sound a beep for 2 seconds then, after a pause, it will sound a lower frequency tone. The D8 is now ready to receive telephone commands.
4. Press the **0** button on the telephone. This tells the D8 that telephone commands will follow. The D8 will respond with either 3 beeps if all OK (One long beep means try again).
5. Now enter a valid User Code (that is normally used for Arming or Disarming the D8) followed by the **#** button.
The D8 will respond with 3 beeps if it recognises the code or 1 long beep to signal the code was invalid and to try again.
6. Enter the required command. See: Summary Of Telephone Commands.
7. Press *** #** to finish. This tells the D8 to hang up. Also hang up your telephone.

NESS ACCESSORIES

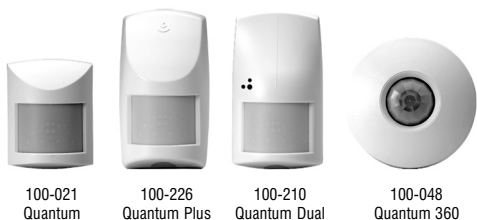

100-021 Quantum
100-226 Quantum Plus
100-210 Quantum Dual
100-048 Quantum 360



MOTION DETECTORS

Ness manufactures a range of high quality and efficient motion detectors - including passive infra-red detectors, dual technology / microwave and infra-red devices as well as ceiling mounted 360° detectors.

All Ness detectors are designed using the most modern technology and techniques that ensure superior reliability and performance.

QUANTUM - 15m passive infra-red detector with selectable pulse count; suitable for domestic and commercial installations. *PetAware model available.*

QUANTUM PLUS - 15m passive infra-red detector with selectable pulse count, temperature compensation and downward looking 'creep' zones.

QUANTUM DUAL - 15m combination microwave and passive infra-red detector. This combination of detection technologies virtually eliminates the possibility of unwanted alarms but faithfully detects humans. *PetAware model available.*

QUANTUM 360 - Ceiling mounted 360° passive infra-red detector with selectable pulse count and sensitivity. Provides 8 metre coverage mounted at standard 2.4 metre ceiling height.

PET AWARE DETECTORS

The Ness Quantum™ Pet Aware PIR and Pet Aware DUAL are able to discriminate between household pets and unwanted human intruders, allowing you to secure your home with your pets indoors.

WARNING DEVICES

The range of warning devices includes horn speakers, polytough siren covers, internal 'screamers' and satellite sirens with their own battery backup.

CCTV

The Ness range of Closed Circuit TV equipment includes Dome cameras, B/W or Colour cameras, Miniature hidden cameras, Monitors - even digital video recorders and remote telephone video systems.

SWITCHES

A variety of switches are available for protecting doors and windows. The line-up includes surface and flush mount reed switches, emergency buttons, roller door reed switches and the unique Nessensor™ vibration sensor for highly effective perimeter protection.



RADIO ACCESSORIES

Ask your installer about the range of Ness radio devices for the optional extra convenience of wireless remote control and wireless detection.

Operating your Ness security system can be as convenient as opening your car door. The Ness Radio Key™ provides the benefits of separate ON, OFF and PANIC buttons in a slim, waterproof remote control.

* Ness radio products require a Ness Radio Interface (100-200) to be fitted to the control panel.



NESS RADIO PENDANT

Fully waterproof pendant style transmitter can be used as a portable wireless Panic button.

Supplied with a neckchain as well as wristwatch straps. Ideal for use as a medical alarm for the elderly or infirm. (Central Station Monitoring is especially recommended when used for medical alarm purposes). Includes long life lithium battery.



NESS RADIO REED SWITCH

Ness Radio Reed Switch for wireless door and window protection. Includes long life lithium battery.



NESS RADIO KEYPAD

A unique fully portable radio keypad. The Ness Radio Keypad provides totally wireless Arming/Disarming of the Ness D8, D16 & D24 control panels.

Also operates Monitor mode and Panic when used with the Ness D16, D24 panels.

The Ness radio Keypad is suitable for use as a portable keypad or for adding an extra keypad in areas where it is not possible to install wires.



NESS RADIO KEY 3 BUTTON

Fully waterproof, ultra slim 3 button Radio Key for remote control of the control panel.

With separate buttons for ON (Arm), OFF (Disarm) and PANIC functions. Includes long life lithium battery.



Pet Aware model also available



NESS RADIO PIR

Ness Radio PIR (Passive Infrared) motion detector for wireless motion detection.

Can be used in combination with Ness hardwired detectors in areas where it is not possible to install wires. Includes long life lithium battery.

Also available, the 100-663PET radio Pet Aware model, which detects humans but is immune to household pets.



NESS RADIO SMOKE DETECTOR

Radio Smoke Detector using Ionisation smoke detection technology. With on board sounder. A single battery powers the smoke detector and the transmitter. Includes 9V lithium battery.

PROGRAMMING OPTIONS SUMMARY

OPTION	DESCRIPTION	DEFAULT	PAGE	OPTION	DESCRIPTION	DEFAULT	PAGE	OPTION	DESCRIPTION	DEFAULT	PAGE			
P00E	Follow Me Tel. No.	none	39	P63E	1E Monitor to RESET OP	OFF	28	P82E	1E Restoral immediately	OFF	41			
P01E-P08E	Enable Radio Devices 1-8	none	56		2E Monitor to STROBE OP	OFF			2E Restoral after Siren Time	OFF				
P09E	Enable Radio Keys 1-8	none	57		3E Monitor to SONALERT	OFF			3E Restoral on Disarm & seal	OFF				
P10E	Enable Radio Keys 9-15	none			4E Monitor to SIREN	OFF			4E Restore on Disarm always	ON				
P11E	User Code 1 (Master)	123	14, 15		5E Day Mode to RESET OP	ON		P83E	Test Call Interval	84=168hrs	42			
P12E-P25E	User Codes 2-15	none				6E Day Mode to STROBE OP	ON		P84E	Time before next Test Call	6=12 hours			
P26E	Entry Delay Time 1	20 sec				7E Day Mode to SONALERT	OFF		P85E	1E Auto Dialling, Pulse & DTMF	ON			
P27E	Entry Delay Time 2	6=60 sec				8E Day Mode to SIREN	OFF			2E Pulse Dialling always	OFF			
P28E	Exit Delay Time	60 sec		P64E	1E 2sec Monitor Alarm	OFF	29, 30	3E DTMF Dialling always		OFF				
P29E	Siren Reset Time	5 min			2E 2sec Day Alarm	ON			P86E	1E Disable Dialler	OFF	43, 44		
P30E	Normal Zone Sens	all zones	16		3E Monitor Zones Entry Delay2	ON				2E Contact ID format	ON			
P31E-38E	Vibration Sens. High-Low	none			4E Radio Key Chirp & Flash	OFF				3E Audible DTMF format	OFF			
P39E	DoubleTrigger Zones	none	17, 18		5E 50Hz Mains Frequency	ON				4E Audible PULSE Format	OFF			
P40E	Instant Zones	Zones 3-8				6E Double Key Keypad Panic		ON			5E Contact ID + Audible DTMF		OFF	
P41E	Entry Delay 1 Zones	Zone 1				7E Keypad Fire Alarm		OFF			6E Contact ID + Audible PULSE		OFF	
P42E	Handover Zones	Zone 2				8E Keypad Medical Alarm		OFF		P87E	1E Split Dial Pri/Sec Phone Nos.	OFF	45	
P43E	Entry Delay 2 Zones	none		P65E	Supervised Radio Zones	none	31	2E Check for Dial Tone	ON					
P44E	Lockout Zones	All zones		P66E	1E Supervision RESET output	OFF	32, 33	4E 4 Dialling attempts	ON					
P45E	AREA 1 Zones	All zones	20		2E Supervision STROBE output	OFF			P88E	1E AREA 1 Open/Close reports	OFF	46, 47		
P46E	AREA 2 Zones	none				3E Supervision SONALERT		OFF			2E AREA 2 Open/Close reports		OFF	
P47E	AREA1 Codes 1-8	All codes	21		4E Supervision SIREN output	OFF				3E Siren Chirp on Kiss-off	OFF			
P48E	AREA1 Codes 9-15	All codes				5E Supervision AUX1 output		OFF			4E Flash Strobe on Kiss-off		OFF	
P49E	AREA2 Codes 1-8	Code 1				6E Supervision AUX2 output		OFF			5E Forced Opening report		ON	
P50E	AREA2 Codes 9-15	none				7E Supervision SpeedUp x 6		OFF			6E Delayed Closing Reports		OFF	
P51E	Monitor Mode Zones	none	19		8E Supervision SpeedUp x10	OFF				7E Manual Exclude Reports	ON			
P52E	24hr Zones	none			P67	Supervision Time	24 hours	31		8E Auto Exclude Reports	ON			
P53E	Day Zones	none			P68E	2E 3K3 Zone Resistors	OFF	34, 35	P89E	1E Enable Test Calls	ON	48, 49		
P54E	Reset OP Zones	All zones		22, 23		3E Radio Panic Toggles AUX1	OFF				2E Mains Report Delay		ON	
P55E	Strobe Zones	All zones				4E Radio Panic Pulses AUX1	OFF				3E Listen-In to Dialler		OFF	
P56E	Sonalert Zones	All zones				5E Radio Arm unseal warning	OFF				4E Swinger shutdown		ON	
P57E	Siren Zones	All zones				6E 24hr Zone Fire Siren	OFF				5E Line Fault Monitor		OFF	
P58E	Aux 1 Zones	none		7E 4th Button RadioKey AUX1		OFF				6E Line Fault to AUX2	OFF			
P59E	Aux 2 Zones	none		8E Quiet chirps on Arm/Disarm		OFF				P90E	1E Enable Up/Download	OFF	50, 51	
P60E	1E Entry Beeps	ON	24, 25	P69E		1E ARM1 Pulse Output	OFF				36, 37	2E Enable Direct Connect		OFF
	2E Ksw Monitor/Disarm	OFF			2E ARM2 Pulse Output	OFF		3E Enable Remote Arming	OFF					
	3E Ksw Arm/Disarm	OFF			3E Quiet Monitor Siren	OFF		4E Enable Remote Disarming	OFF					
	4E Tamper siren lockout	ON			4E 6 Beeps on Arming	OFF		5E Enable Remote AUX control	OFF					
	5E Duress to Reset OP	OFF			5E Radio Key Monitor Arm	OFF		6E Enable Remote Status report	OFF					
	6E Auto Exclude Zones	ON		P70E	Telephone No.1 Primary	none	38	7E Enable Remote Event Report	OFF					
	7E Auto KP display off	OFF		P71E	Telephone No.2 Secondary	none			8E Enable Callback Mode		OFF			
	8E Delay Arm1,2 outputs	OFF		P72E	Account No. 1	0000			P91E	Required rings to answer	1	52		
P61E	1E Tamper to Reset OP	ON	26	P73E	Account No. 2	0000		P92E	1E Report Radio Tamper	ON	41			
	2E Tamper to Strobe OP	ON		P74E	Report ZONE Alarms 1-8	All zones	40, 41		2E Report Radio Panic by User	ON				
	3E Tamper to Sonalert	ON		P75E	Report misc. ALARMS 1-8	1E Report Duress			OFF	3E Report Radio Battery by device		OFF		
	4E Tamper to Siren	ON				2E Report Medical			OFF	4E Report Supervision fail		OFF		
	5E KP Panic to Reset OP	ON				3E Report K/P & K/S Panic			ON	5E Report Panel Battery		ON		
	6E KP Panic to Strobe Op	ON				4E Report Fire			OFF	6E Report Mains Fail		ON		
	7E KP Panic to Sonalert	ON				5E Report Panel Tamper		ON						
	8E KP Panic to Siren	ON				6E Report External Tamper		ON						
		7E Report Keypad Tamper	ON											
		8E Report Exit Install Mode	OFF											
P62E	1E S/cut Memory display	ON	27, 28	P76E	Report Zone Restorals 1-8	All zones	P93E	Report MISC. Restorals 9-14	All on	41				
	2E S/cut Zone Exclude	ON		P77E	Report MISC. Restorals 1-8	All on	P95E	Clear Radio Devices		53				
	3E S/cut Monitor Mode	ON		P78E	Report Multiple Zone alarms	none	P96E	Clear Memory						
	4E S/cut Keypad Panic	OFF		P79E	Account No.2 Zones	none	P97E	Clear panel options						
	5E S/cut Area 1 Arm	ON		P80E	Telephone No. 3 for Test Calls	none	39	P98E	Clear User codes					
	6E S/cut Area 2 Arm	OFF		P81E	Telephone No.4 for Callback	none	39	P99E	Set Installer code	000000	53			
	7E Auto Exclude 2s Warn	ON												
	8E Exit Time x 10	OFF												

These options are available in User Program Mode.
ALL options are available in Installer Program Mode

INSTALLATION RECORD



NESS D8 ALARM CONTROL PANEL

P26E ENTRY DELAY TIME 1

P27E ENTRY DELAY TIME 2

P28E EXIT DELAY TIME

P29E SIREN RESET TIME

	Seconds
	Seconds
	Seconds
	Minutes

Date purchased:	Date installed:
Installation Company:	
Telephone:	

Monitoring Company:
Telephone:

ZONE ASSIGNMENT

- P41E ENTRY DELAY 1
- P43E ENTRY DELAY 2
- P42E HANDOVER
- P40E INSTANT
- P45E AREA 1
- P46E AREA 2
- P51E MONITOR
- P52E 24 HOUR
- P54E RESET OUTPUT
- P55E STROBE OUTPUT
- P56E SONALERT OUTPUT
- P57E SIREN OUTPUT
- P74E Report (dialler)

ZONES	DEVICE TYPE	PIR, Reed switch, etc	DESCRIPTION	Entrance, bedroom1, etc														
1																		
2																		
3																		
4																		
5																		
6																		
7																		
8																		

CODE	OPTION No	CODE HOLDER	AREA 1	AREA 2	RADIO KEY CODE (Y/N)
User Code 1 ^{Master Code}	P11E				(Keypad Code only)
User Code 2	P12E				
User Code 3	P13E				
User Code 4	P14E				
User Code 5	P15E				
User Code 6	P16E				
User Code 7	P17E				
User Code 8	P18E				
User Code 9	P19E				
User Code 10	P20E				
User Code 11	P21E				
User Code 12	P22E				
User Code 13	P23E				
User Code 14	P24E				
User Code 15	P25E				

